

White Paper Disaster Management in Japan 2015

Summary

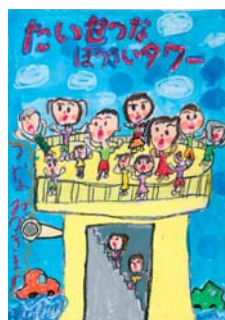

Images: Prize-winning Works of the 30th Disaster Management Poster Contest

“The White Paper on Disaster Management is one of Japan’s most noteworthy initiatives in the field of disaster risk reduction and management. Few countries publish such comprehensive reports on a regular basis. Other countries can learn from Japan’s example and adapt this model to their own needs.”

- Ms. Margareta Wahlstrom, the Special Representative of the United Nations Secretary-General for Disaster Risk Reduction/ Head of the United Nations Office for Disaster Risk Reduction (UNISDR)



Foreword

The White Paper on Disaster Management in Japan was first published in 1963 pursuant to the Disaster Countermeasures Basic Act. This, the 53rd edition, was reported to the National Diet after cabinet approval on June 19, 2015.



This year's white paper highlights the Third UN World Conference on Disaster Risk Reduction (WCDRR), which was held in Sendai in March of this year. It was entitled the United Nations World Conference on Disaster Risk Reduction and Japan's International Cooperation on Disaster Risk Reduction. Ms. Margareta Wahlström, United Nations Special Representative of the Secretary-General for Disaster Risk Reduction, provided a message for this white paper.

This white paper looks at the revisions made to disaster countermeasures based on the heavy snows in February of last year, the landslide in Hiroshima in August, and the eruption of Mt. Ontake in September. It also provides information on the latest disaster risk reduction initiatives implemented by the national government, local governments, and community residents, and introduces a case study on an earthquake centered in northern Nagano Prefecture in which no casualties occurred thanks to mutual community support.

Even if we cannot eliminate the occurrence of natural hazards, we are confident that it is possible to mitigate disaster impacts using both the instinct to survive and the wisdom with which human beings are naturally equipped. In English, the Japanese terms *bosai* or *gensai* are translated as "disaster risk reduction," abbreviated DRR. At the last World Conference, we shared with the international community an important precept in Japan: "DRR is our DNA."

Based on the view that disaster countermeasures are never "costs," but rather investments in the future, the Government of Japan is wholeheartedly committed to achieving safe and secure living. We therefore intend to proactively request that all citizens of Japan maintain a reasonable awareness of natural threats, be well prepared in advance for the hazards they face, refuse to react to false alarms, and take actions to protect themselves from disasters.

We hope that all readers of this White Paper gain an understanding of Japan's disaster management efforts and cooperate even further in their implementation.

Eriko Yamatani
Minister of State for Disaster Management, Japan
July 2015

**Message from the Special Representative of the United Nations
Secretary-General for Disaster Risk Reduction
for the White Paper on Disaster Management "*Bosai Hakusho* 2015"**

Thanks to close cooperation between Japan and the United Nations, the Third United Nations World Conference on Disaster Risk Reduction (March 14-18) was successfully organized and concluded with positive outcomes. In particular, the Sendai Framework for Disaster Risk Reduction 2015-2030 adopted by Member States at the Conference provides a strong foundation for the continued work on reducing disaster risk and impacts for the coming 15 years. It is also an essential part of the Post-2015 Development Agenda and a clear boost for ongoing work on agreements later this year on climate and a new set of sustainable development goals.



Through hosting the World Conference now on three occasions, (Yokohama, 1994, Hyogo, 2005, and Sendai, 2015), Japan has demonstrated its strong commitment to disaster risk reduction and shared with the international community a wide range of lessons and good practices building on its own disaster experiences.

One of Japan's most noteworthy initiatives in the field of disaster risk reduction and management is the publication of this *Bosai Hakusho*, the White Paper on Disaster Management. This annual report provides comprehensive information including disaster losses and relevant data and statistics; updates on the progress of recovery and reconstructions from specific disasters; policies and measures for disaster management by disaster type; and insights into good practices on disaster risk reduction/prevention at local/community level, and much more.

This White Paper is a well-established publication and few countries publish such comprehensive reports on a regular basis, totally dedicated to disaster risk management. This report helps us better understand how Japan has developed its disaster risk management policies and measures over a period of time. Other countries can learn from Japan's example and adapt this model of annual reporting to their own needs in the context of monitoring progress on implementation of the Sendai Framework for Disaster Risk Reduction, particularly under the four priority areas of action:

- 1: *Understanding disaster risk;*
- 2: *Strengthening disaster risk governance to manage disaster risk;*
- 3: *Investing in disaster risk reduction and resilience;*
- 4: *Enhancing disaster preparedness for effective response, and to "Build Back Better" in recovery, rehabilitation and reconstruction.*

The World Conference confirmed the importance of enhanced international cooperation and global partnership on disaster risk reduction. As the Head of UNISDR, I would like to extend our appreciation to Japan for its ongoing support and commitment to the area of disaster risk reduction and reiterate my strong wish that Japan will continue to work with various stakeholders in the international community and demonstrate leadership in the global efforts towards the achievement of the goals of the Sendai Framework for Disaster Risk Reduction.

Margareta Wahlström
The Special Representative of the United Nations Secretary-General
for Disaster Risk Reduction
Head of the United Nations Office for Disaster Risk Reduction (UNISDR)

TABLE OF CONTENTS

Introduction

Part I	The United Nations World Conference on Disaster Risk Reduction and Japan's International Cooperation on Disaster Risk Reduction (DRR): Toward Mainstreaming DRR in International Society	1
Chapter I	Background to the United Nations World Conference on Disaster Risk Reduction	1
Section 1	International Decade for Natural Disaster Reduction and the First UN World Conference on Natural Disaster Reduction	2
Section 2	Establishment of the UNISDR and the Second UN World Conference on Disaster Reduction	2
Section 3	The Progress and Challenges of Initiatives Based on HFA	3
Chapter II	The Third UN World Conference on Disaster Risk Reduction (WCDRR)	4
Section 1	Preparations for the Third WCDRR	4
Section 2	Overview of the Third WCDRR	4
Chapter III	Japan's International Cooperation on Disaster Risk Reduction (DRR)	11
Section 1	Overview	11
Section 2	DRR Cooperation through the UN and the Other International Organizations	11
Section 3	DRR Cooperation in the Asia-Pacific Region	13
Section 4	Bilateral Disaster Risk Reduction Cooperation	15
Part II	Status of Disaster Management Measures in Japan	18
Chapter I	Status of Disaster Management Policies	18
Section 1	Disaster Management Systems and Disaster Preparedness	18
Section 2	Disaster Response and Preparedness	21
Section 3	Initiatives to Support Disaster Victims	26
Section 4	Promotion of DRR Activities in Coordination with Various Stakeholders	27
Section 5	Recovery and Reconstruction Measures	28
Section 6	Efforts to Promote National Resilience	29
Chapter II	Status of Disaster Management Measures for Each Type of Potential Disaster	30
Section 1	Earthquake and Tsunami Disaster Management	30
Section 2	Volcano Disaster Management	31
Section 3	Sediment Disaster Management	33
Chapter III	Measures for Nuclear Disasters	35
Section 1	Review of the Nuclear Regulation Authority (NRA) and the Cabinet Office Nuclear Disaster Management System	35
Section 2	Bolstering Nuclear Disaster Management and Radiation Monitoring Under the NRA	36
Section 3	Implementation of a Comprehensive Nuclear Disaster Drill in FY2014	37

INTRODUCTION

The Third UN World Conference on Disaster Risk Reduction (WCDRR) was held in Sendai, Miyagi Prefecture from March 14 to 18, 2015, four years after the Great East Japan Earthquake. Over 100 ministers from 187 UN member states, including 25 heads of state and government, the Secretary-General of the UN, and the Administrator of the United Nations Development Programme (UNDP) participated, making it one of the largest UN conferences ever held in Japan. At the Conference, the Sendai Framework for Disaster Risk Reduction (SFDRR) 2015-2030 was formulated as a new initiative and guideline for disaster risk reduction (DRR). With this, the initiatives of the international community entered a new stage aimed at the further promotion of the mainstreaming of disaster risk reduction. In addition, related events were conducted such as symposiums and seminars on disaster risk reduction and recovery, exhibitions, a DRR Industry Exhibition ("Bosai" Industry Fair), study tours of disaster-affected areas, and post-conference excursions to various locations in the Tohoku region.

Through these initiatives, the Conference served to once again express Japan's gratitude to countries all over the world for the assistance received after the Great East Japan Earthquake, and allowed Japan to share the lessons learned and technologies Japan has developed through this and earthquake and other disasters. The Conference also presented the current state of recovery and efforts related to the Great East Japan Earthquake and provided an important opportunity to contribute to the promotion of disaster-stricken areas.

Part I of the White Paper on Disaster Management in Japan 2015 highlights the "United Nations World Conference on Disaster Risk Reduction and Japan's International Cooperation on Disaster Risk Reduction." It looks at the background leading up to the implementation of the third WCDRR, the nature of the discussions that were held there, and how the SFDRR will be promoted to achieve even greater mainstreaming of disaster risk reduction.

Part II, on the "Status of Disaster Management Measures in Japan," looks at the state of measures and policy initiatives with a particular focus on those implemented in FY 2014, including:

- A description of revisions to the Disaster Countermeasures Basic Act adopted in November 2014 based on the great number of abandoned cars and transportation blockages caused by delays in snow removal operations during the heavy snows of February 2014.
- A description of the revised content of and initiatives related to the Act on the Promotion of Sediment Disaster Countermeasures in Sediment Disaster Prone Areas, which was revised in November 2014 based on issues such as the numerous areas which were not designated as the sediment disaster hazard areas and which had not been subject to basic surveys, and the insufficient communication of the risks of sediment disasters to residents.
- A description of the Plan concerning Specific Emergency Countermeasures and Activities for a Nankai Trough Earthquake, which was formulated and established in March 2015 at the Officers' Meeting of the Central Disaster Management Council pursuant to Chapter 4 of the Basic Plan for the Promotion of Nankai Trough Earthquake Disaster Risk Reduction Countermeasures.
- A description of the revised content of the Basic Plan for the Promotion of Tokyo Inland Earthquake Emergency Countermeasures, which was revised and approved by the Cabinet in March 2015 pursuant to the Act on Special Measures against Tokyo Inland Earthquake.
- A description of the content of the "Report on Future Volcano DRR Promotion Based on Lessons from the Eruption of Mt. Ontake," which was compiled in March 2015 after the establishment and investigations of the Working Group for the Promotion of Volcano Disaster Prevention under the Central Disaster Management Council's Disaster Management Implementation Committee based on the large number of casualties caused by the eruption of Mt. Ontake in September 2014.

About the White Paper on Disaster Management in Japan

The White Paper on Disaster Management in Japan is a report designated by law to be drawn up and reported annually to the ordinary session of the Diet pursuant to the Disaster Countermeasures Basic Act. The White Paper was first published in 1963. This is the 53rd edition.

In addition to providing an overview of measures taken concerning disasters in the year before last (FY2013) and plans concerning disaster risk reduction for the current year (FY2015), each report features a theme based on the current state of DRR policies at the time it was written.

Background of UN World Conference on Disaster Risk Reduction

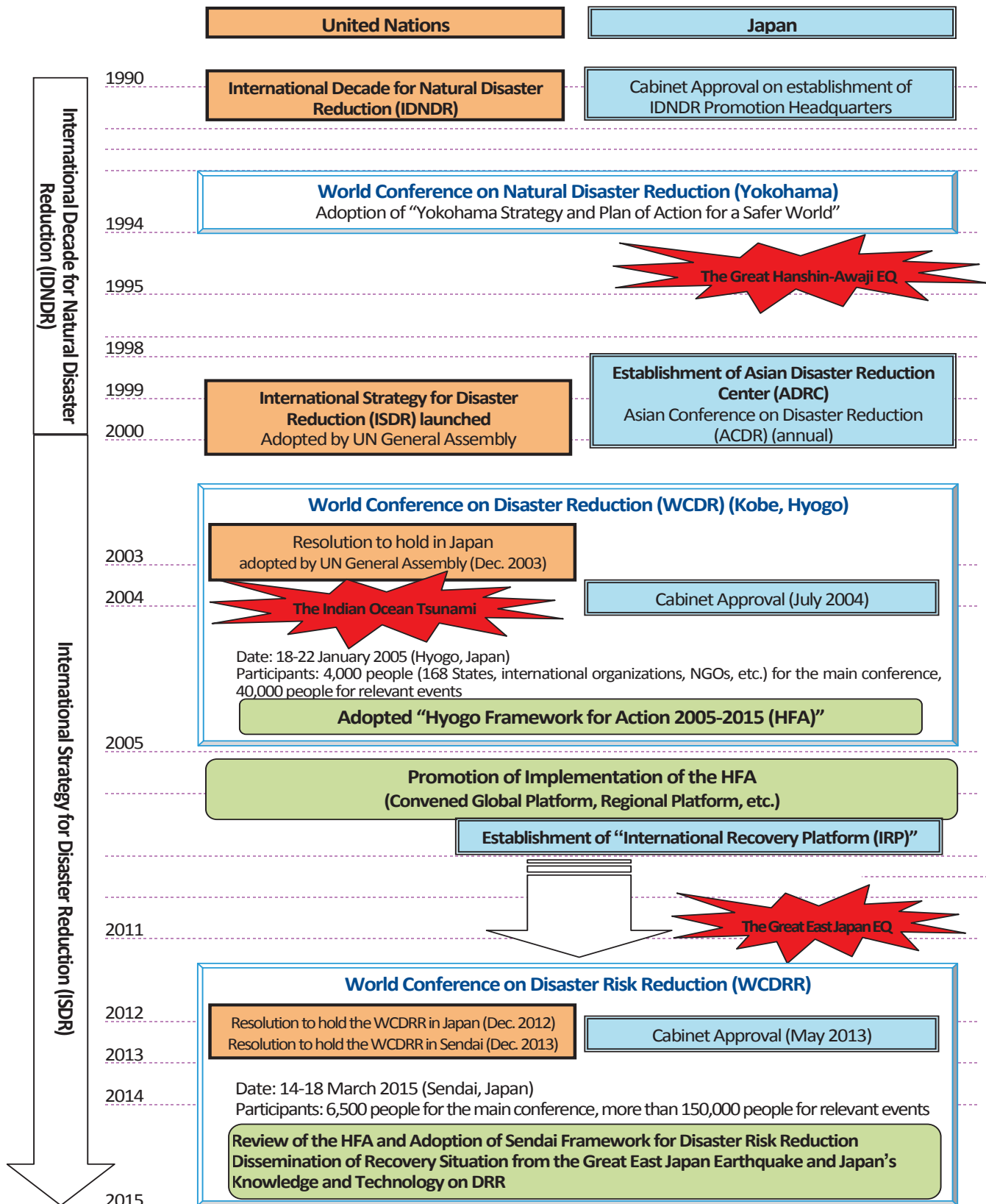

Section 1: International Decade for Natural Disaster Reduction and the First UN World Conference on Natural Disaster Reduction

The UN designated the 1990s as the International Decade for Natural Disaster Reduction (IDNDR). In 1994, the midway point of the decade, the First UN World Conference on Natural Disaster Reduction was held in Yokohama, resulting in the adoption of the Yokohama Strategy and Plan of Action for a Safer World: Guidelines for Natural Disaster Prevention, Preparedness and Mitigation.

“Yokohama Strategy and Plan of Action for a Safer World” (Yokohama Strategy)

I. Basis for the Strategy

Sustainable economic growth and sustainable development cannot be achieved in many countries without adequate measures to reduce disaster losses by development of disaster resilient societies and disaster prevention and preparedness

II. Principles

- Risk Assessment is a required step for the adoption of adequate disaster reduction policies and measures
- Disaster prevention and preparedness are of primary importance in reducing the need for disaster relief, etc.

III. Strategy for the Year 2000 and beyond

- Development of a global culture of prevention, capacity building in each disaster vulnerable country and community, education and training in disaster prevention, preparedness, and mitigation, networking so as to enhance disaster prevention, reduction and mitigation activities, more active and constructive role of media, improved risk assessment, etc.

IV. Plan of Action

(Activities at the community and national levels)

(Activities at the regional and sub-regional levels)

Establishing or strengthening of sub-regional or regional centres for disaster reduction and prevention which, with a view to enhancing national capabilities, would perform the functions of collecting and disseminating documentation and information for disaster reduction, human resource development, supporting and strengthening natural disaster reduction mechanisms

(Activities at the international level)

Section 2: Establishment of the UNISDR and the Second UN World Conference on Disaster Reduction

As the successor arrangements for the IDNDR, in 2000 the United Nations initiated the International Strategy for Disaster Reduction (ISDR) and established the United Nations Office for Disaster Risk Reduction (UNISDR). In January of 2005, the Second UN World Conference on Disaster Reduction was held in Kobe, Hyogo Prefecture, where the Hyogo Framework for Action 2005-2015 (HFA) was adopted. In addition, the International Recovery Platform (IRP) began operations in Kobe, Hyogo, backed by the Government of Japan.

Hyogo Framework for Action 2005-2015

-Building the Resilience of Nations and Communities to Disasters-

[Expected Outcome]

The substantial reduction of disaster losses, in lives and in the social, economic and environmental assets of communities and countries

[Three Strategic Goals]

- a) The integration of disaster risk reduction into sustainable development policies and planning
- b) The development and strengthening of institutions, mechanisms and capacities at all levels, in particular at the community level, that can contribute to building resilience to hazards
- c) The systematic incorporation of risk reduction approaches into the implementation of emergency preparedness, response and recovery programmes

[Five Priorities for Action]

- (1) **Ensure that disaster risk reduction (DRR) is a national and a local priority with a strong institutional basis for implementation**
Creation of National institutional and legislative frameworks, etc.
- (2) **Identify, assess and monitor disaster risks and enhance early warning**
National and local risk assessments (Development of risk maps, Development of systems of indicators of disaster risk), etc. and vulnerability
- (3) **Use knowledge, innovation and education to build a culture of safety and resilience at all levels**
Information exchange, research, public awareness (engagement of media, sustained public education campaign), etc.
- (4) **Reduce the underlying risk factors**
Improvement of earthquake resistance of the important public facilities and infrastructure, etc.
- (5) **Strengthen disaster preparedness for effective response at all levels**
Preparation of contingency plans and policies at all levels, promotion of disaster preparedness exercises, etc.

Section 3: The Progress and Challenges of Initiatives Based on HFA

3-1 Progress of Initiatives Based on the HFA

The UNISDR has been monitoring progress on initiatives implemented by various countries in line with the HFA. Based on Priority Action 1, disaster management organizations and systems have been established in each country. For the achievement of Priority Action 5, disaster response systems, including early warning systems, have been strengthened.

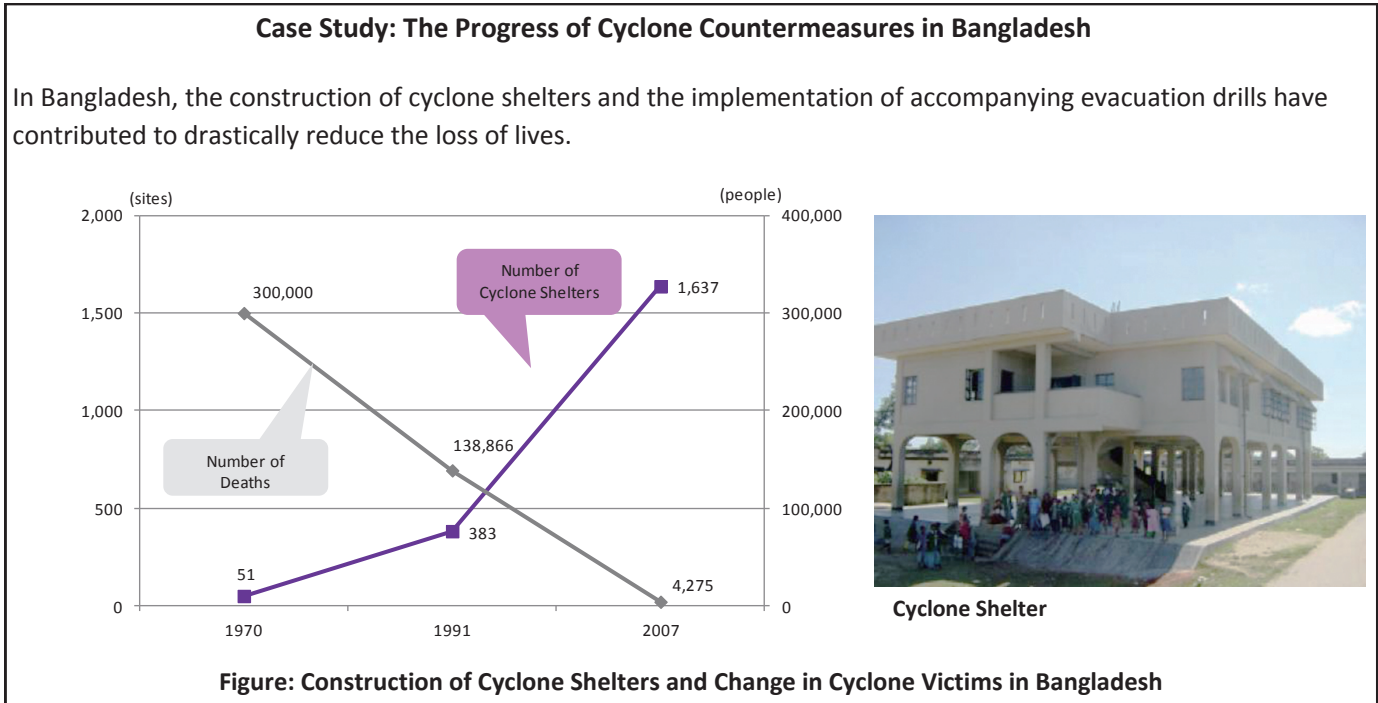

3-2 Disaster Risk Reduction Challenges Since 2005

While disaster risk reduction initiatives based on the HFA have progressed, the global risk of disaster has increased due to urbanization around the world, globalization, and changing meteorological disasters.

3-3 Disaster Risk Reduction Challenges in Developing Countries: The Vicious Cycle of Disasters and Poverty

Economic damage due to natural disasters is a major obstacle to the sustainable development of developing countries. Urgent challenges include the need for initiatives aimed at reducing societal vulnerability to disasters, as well as the adoption of development policies that reduce the exposure to hazards and decrease their impact.

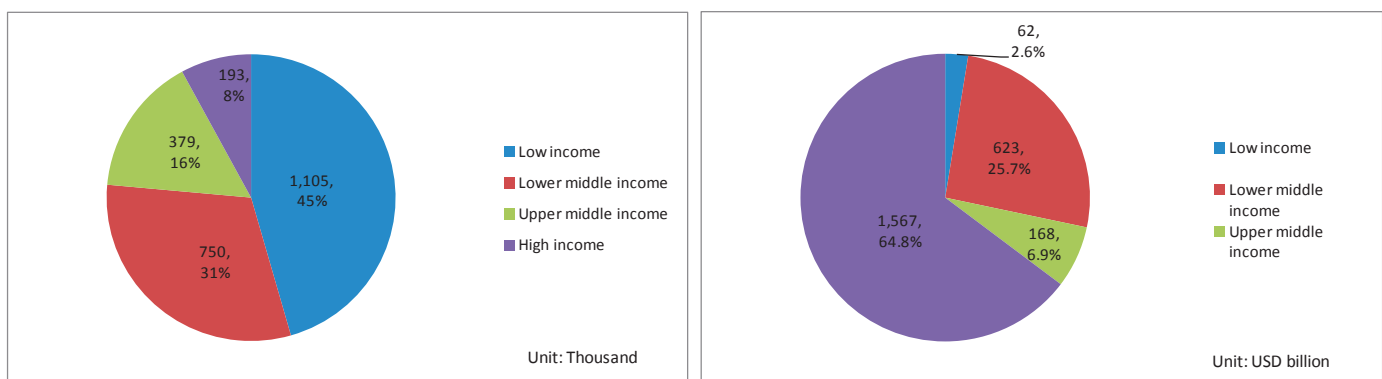

Section 1: Preparations for the Third WCDRR

1-1 UN-Led Preparations

Representatives of the Government of Japan participated in Regional Platforms held in various regions starting in April 2014 as well as in Intergovernmental Preparatory Committee meetings (PrepCom) convened in July and November of the same year in Geneva. In addition to proposing a new disaster risk reduction framework, the Government of Japan also provided information on the status of Conference preparations.



The discussion on the new disaster risk reduction framework was initiated at the November PrepCom and further discussions continued thereafter, leading to continued negotiations during the Conference.

1-2 Preparations in Japan

National Preparatory Meetings for the Third WCDRR were held to investigate Japan's proposal for a new DRR framework, the current state of recovery from the Great East Japan Earthquake, and mechanisms for the sharing of Japan's expertise, including the lessons learned from previous disasters. These meetings were attended by scholars, disaster-related organizations, and local governments in the disaster-stricken areas of Tohoku, among others, and were held five times starting in February 2014.

In the City of Sendai, the Sendai Committee for the WCDRR was established. It was comprised of representatives from Sendai City, Tohoku University, the local business community, the Government of Japan, the six prefectures of the Tohoku region, and other relevant organizations. The committee coordinated with local interested parties and governments to investigate the implementation of such matters as support for the Conference, related programs, welcome events, and projects to highlight the appeal of the City of Sendai and the Tohoku region.

Section 2: Overview of the Third WCDRR

<Program of the UN World Conference on Disaster Risk Reduction>

	Saturday 14 March		Sunday 15 March		Monday 16 March		Tuesday 17 March		Wednesday 18 March					
	AM	PM	AM	PM	AM	PM	AM	PM						
Intergovernmental	Opening	Plenary Sessions (Adoption of rules of procedure of the Conference, etc.)	Plenary Sessions Official Statements (Delivery of the official statements by the member states and stakeholders according to the official speakers list)						Adoption of a Post-2015 Framework for DRR, Official Declaration, and Stakeholders' Commitment	Closing				
			Ministerial Roundtables											
			High Level Partnership Dialogues											
Multi-Stakeholder	Working Sessions													
	Public Forum (Symposium, Forum, Exhibition, etc.) (Venue: Tohoku University Centennial Hall, Sendai Civic Auditorium, Tokyo Electron Hall Miyagi, Sendai Mediatheque, Yumemesse Miyagi, etc.)													
				Reception hosted by Japan			Reception hosted by Sendai city			Risk Award Ceremony		Sasagawa Award Ceremony		
Excursions (Study Tours)										Excursions				

Major Conference Venues in Sendai

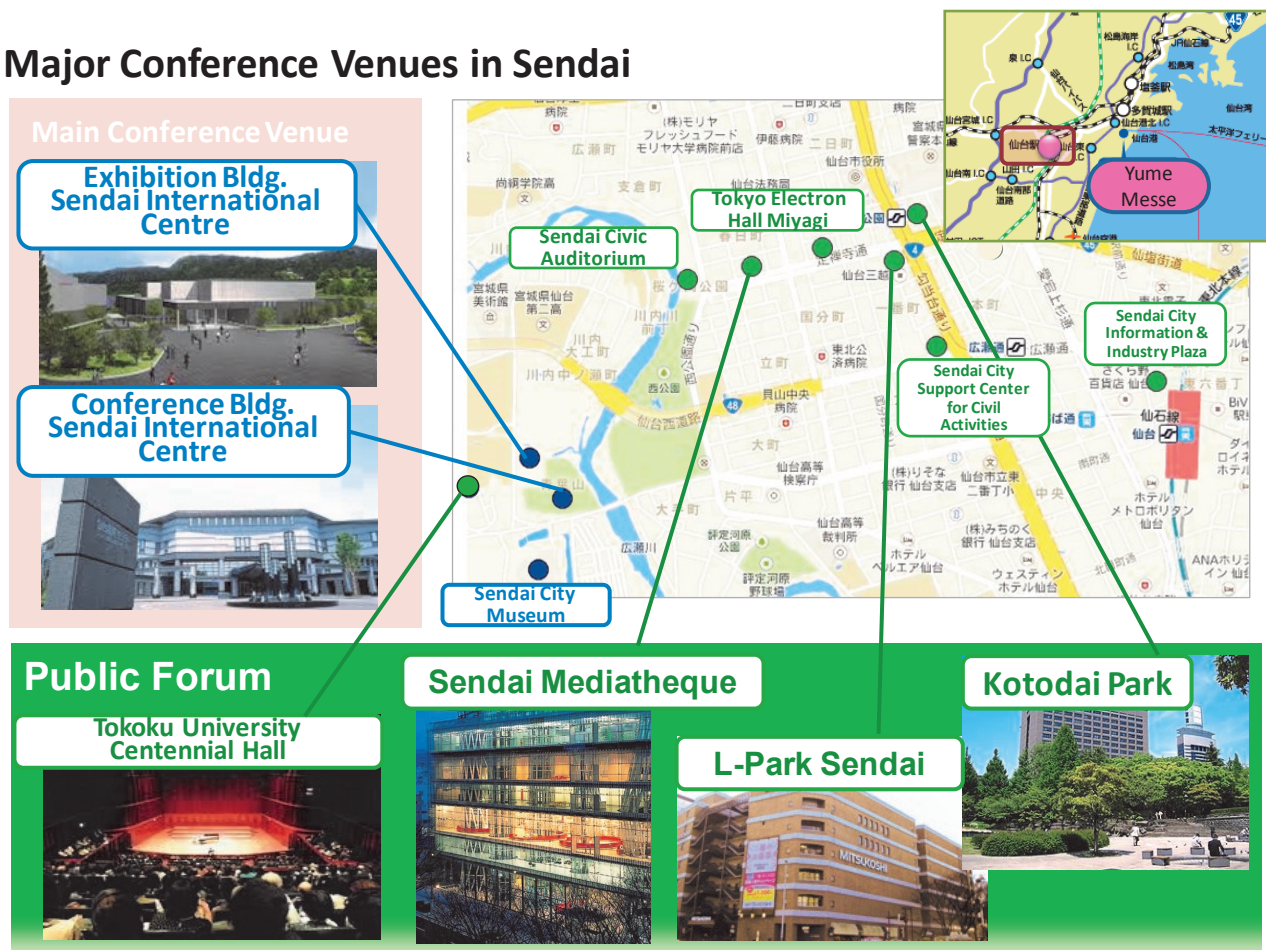

*Some related events were conducted in Iwate Prefecture and Fukushima Prefecture.

2-1 Overview of the Conference

- The Conference was held in Sendai, Miyagi Prefecture from March 14-18, 2015.
- More than 6,500 people participated, including representatives from 187 UN member states, international organizations, and accredited NGOs (also, more than 100 ministers, including 25 heads of state and government, the UN Secretary-General, and the UNDP Administrator). More than 150,000 people attended all related conference events, making this one of the largest UN-led international meetings to be held in Japan.
- Eriko Yamatani, the Minister of State for Disaster Management, served as the president of the Conference.
- The conference program included the Plenary Sessions (featuring statements from each of the participating countries), Ministerial Roundtables (five sessions), High Level Partnership Dialogues (three sessions), and Working Sessions (34 sessions).
- Outcome documents of the Conference include the Sendai Framework for Disaster Risk Reduction (SFDRR) 2015-2030, the successor framework to the Hyogo Framework for Action (HFA) 2005-2015 which was adopted at the Second WCDRR, as well as the Sendai Declaration, which expresses the resolution to promote the new framework.
- Related events included symposia and seminars on DRR and recovery, exhibitions, the “Bosai” Industry Fair, study tours of disaster-stricken areas, and post-conference excursions to various locations in the Tohoku region.

2-2 Official Programme

(1) Opening Ceremony

The opening ceremony was held on the morning of March 14, with the Emperor and Empress of Japan attending. Conference President Eriko Yamatani, Secretary-General of the United Nations Ban Ki-moon, and Prime Minister Shinzo Abe gave remarks to those assembled. Remarks were also given by personages such as Laurent Fabius, French Minister of Foreign Affairs and International Development, serving as president of COP21, and the Mayor of Sendai City Emiko Okuyama.



<Opening Ceremony>



<Official Statement by Prime Minister Shinzo Abe>

(2) Plenary Sessions

During the high level segment, Prime Minister Abe gave a statement emphasizing the importance of prior investment in disaster risk reduction, better disaster recovery (termed “Build Back Better”), and the participation of diverse stakeholders. Prime Minister Abe also announced the Sendai Cooperation Initiative for Disaster Risk Reduction (SCIDRR), setting forth a policy of sharing Japan’s expertise and technologies with the world and declaring Japan’s intention to engage in international cooperation in the field of disaster risk reduction by providing a total of USD 4 billion in financial assistance as well as human resources development for 40,000 people over the four-year period from 2015 to 2018.

(3) High Level Partnership Dialogues

Saturday, 14 March	Mobilizing Women's Leadership in Disaster Risk Reduction
Monday, 16 March	Risk Sensitive Investment: Public-Private Partnerships
Tuesday, 17 March	Inclusive Disaster Risk Management: Governments, Communities and Groups Acting Together

Japan’s contributions included a presentation by Sanae Takaichi, Minister for Internal Affairs and Communications, Japan who co-chaired the dialogue on “Mobilizing Women’s Leadership in Disaster Risk Reduction,” and Prime Minister Abe’s keynote speech, in which he discussed women’s leadership during the Great East Japan Earthquake and announced the start of the Training to Promote Leadership by Women in Disaster Risk Reduction as a key project of the SCIDRR.

(4) Ministerial Roundtables

Sunday, 15 March	Reconstructing After Disasters: Building Back Better
Sunday, 15 March	International Cooperation in Support of a Post-2015 Framework for Disaster Risk Reduction
Monday, 16 March	Governing Disaster Risk: Overcoming Challenges
Monday, 16 March	Reducing Disaster Risk in Urban Settings
Tuesday, 17 March	Public Investment Strategies for Disaster Risk Reduction

Japan’s contributions included the session on “Reconstructing After Disasters: Build Back Better,” held on the morning of March 15. During this session, Akihiro Ota, Minister for Land, Infrastructure, Transport and Tourism (MLIT), provided an explanation of initiatives launched based on the lessons learned from such disasters as the Great Hanshin-Awaji Earthquake and the Great East Japan Earthquake, and stressed the importance of precautionary investment. In addition, Fumio Kishida, Minister for Foreign Affairs, attended the session on “International Cooperation in Support of a Post-2015 Framework for Disaster Risk Reduction” held in the afternoon of the same day. He spoke of Japan’s determination to promote international cooperation in DRR based on the SCIDRR .



<High Level Partnership Dialogues>



<Ministerial Roundtables>

(5) Working Sessions

Saturday, 14 March –	34 sessions were held focusing on the following themes: 1) Progress on existing Hyogo Framework for Action 2010-2015: Building the Resilience to Nations and Communities Priorities
Tuesday, 17 March	2) Emerging risks (earthquake and tsunami, technological disasters including nuclear disasters, etc.) 3) Commitments to implementation (private sectors, academia, science technology, disabilities, etc.) 4) Accelerating implementation (cultural heritage, building codes, disaster insurances, etc.)

The session on “Governance and Development Planning at the National/Local Levels (Priority 1)” included a panel discussion featuring Ryosei Akazawa, State-Minister of the Cabinet Office, Japan. He emphasized the importance of increasing DRR awareness among citizens and finding the optimum combination of structural and non-structural measures.

(6) Conference Venue Exhibits

Exhibits at the conference venue included several by overseas organizations such as the UN, nine major groups, and a group of disabled persons. Exhibits were also hosted in cooperation with relevant Japanese ministries, agencies, and local governments (Tokyo and Hyogo Prefecture), the Japan Aerospace Exploration Agency (JAXA), the Japan International Cooperation Agency (JICA), and NHK (Japan Broadcasting Corporation).



<Working Session (attended by Ryosei Akazawa, State Minister of Cabinet Office)>



<Exhibition Booths in the Conference Building>

2-3 Outcome Documents

The session to adopt the outcome documents for the plenary session was held in the late evening of March 18. Drafts of the Sendai Framework for Disaster Risk Reduction (SFDRR) 2015-2030 and the Sendai Declaration, compiled just prior to the session by the Main Committee, were reported by committee co-chairs. Conference President Yamatani presented these documents for deliberation at the plenary session, with both documents being adopted unanimously. In her remarks at the closing ceremony, Conference President Yamatani expressed her thanks to the Conference participants and all who had participated in the organization of the event. She also declared her intention to

strengthen DRR initiatives at the global, regional, national, and community levels under the SFDRR, and to work to ensure that the new development agenda and climate change framework integrate the perspective of disaster risk reduction. She also alluded to promoting initiatives to promote self-help and mutual help. Given that November 5 is Tsunami Preparedness Day in Japan, she proposed that the establishment of a World Tsunami Awareness Day would help raise awareness of DRR around the world.



<Main Committee>



<Adoption of the Outcome Documents>

(1) Sendai Framework for Disaster Risk Reduction (SFDRR) 2015-2030

The SFDRR was adopted as the successor to the HFA 2005-2015, and includes stipulations regarding the expected outcomes and goals, guiding principles, priorities for action, roles of stakeholders, and international cooperation and global partnership.

The SFDRR fully reflects the importance of prior DRR investment, “Build Back Better,” and governance involving diverse stakeholders, all of which were emphasized by Japan from the negotiation stage of this framework. It also reinforces initiatives designed to reduce the underlying risk factors—a challenge in the HFA initiatives—and its content is quite substantial.

“Sendai Framework for Disaster Risk Reduction 2015-2030”

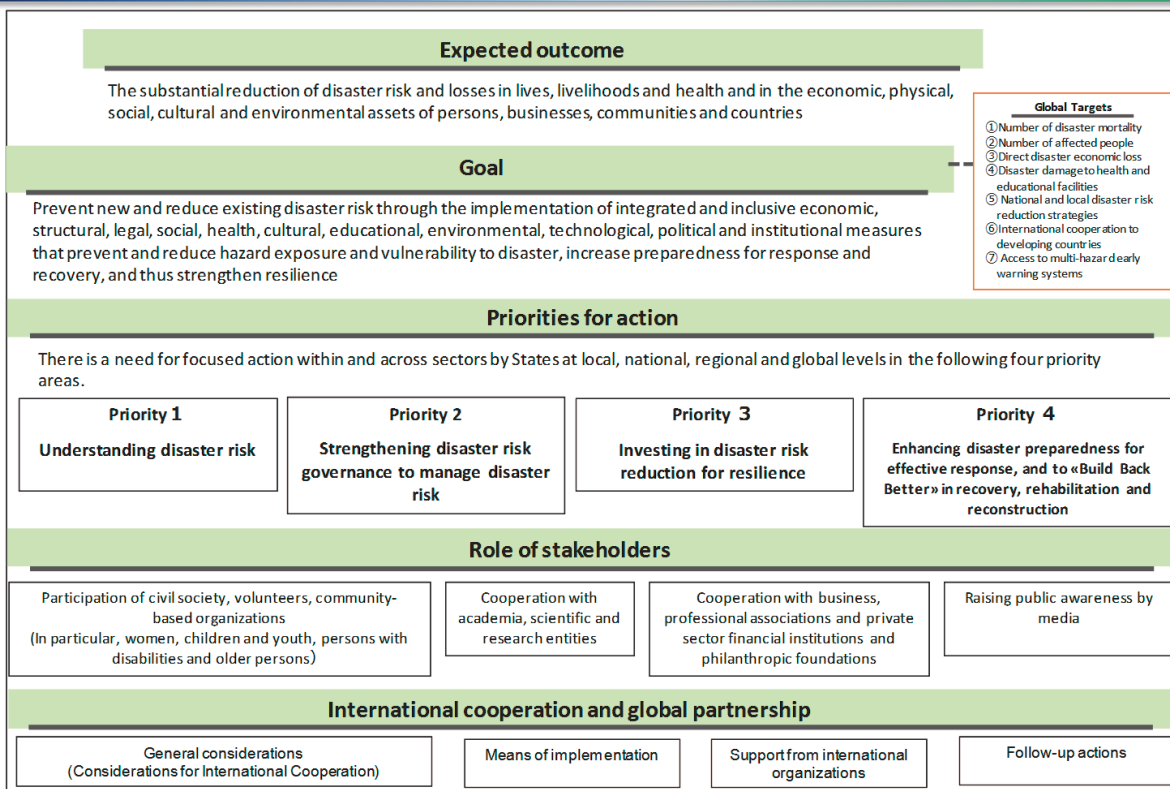

(2) Sendai Declaration

The Sendai Declaration expresses the political commitment of each country to disaster risk reduction and was adopted to promote the SFDRR.

2-4 Related Events

As part of the Third WCDRR, related events providing information on initiatives concerning disaster risk reduction, disaster mitigation, and reconstruction were held at venues surrounding the main Conference venue. The events were conducted by a diverse array of stakeholders, both domestic and overseas, including government agencies, local governments, NPOs, NGOs, universities, and regional organizations.

The Great East Japan Earthquake Forum was held to provide perspectives on better disaster recovery and new DRR methods that leverage the experience and lessons gained from the Great East Japan Earthquake. As the Forum was hosted by the Cabinet Office of Japan welcome remarks were given by Yohei Matsumoto, Parliamentary Vice-Minister of the Cabinet Office. In addition, approximately 400 symposiums and seminars were held in Sendai and at venues in neighboring prefectures affected by quake. There were both indoor and outdoor exhibitions, such as the Tohoku Reconstruction and Disaster Risk Reduction Pavilion and the DRR Exhibition. Further, the “Bosai” Industry Fair was held to display Japanese technologies and products related to DRR, and two halls covered the themes of “Civil Society Collaboration and Disaster Risk Reduction” and “Women and DRR.”

A total of 42 study tours on 25 topics were organized for Conference participants from around the globe in order to provide information on the state of recovery from the Great East Japan Earthquake and to highlight initiatives to “Build Back Better.” After the Conference, five excursion tours were held to enable participants to experience the culture and food of the prefectures in the Tohoku region.



<Special Forum attended by Yohei Matsumoto, Parliamentary Secretary, Cabinet Office >

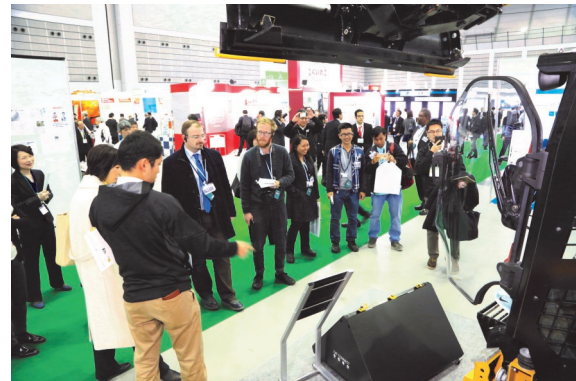

<“Bosai” (DRR) Industry Fair>



<Pavilion “Revival from the Great East Japan Earthquake and the Way Forwards”>



<Study Tour>

2-5 Follow-up Activities

(1) Implementation of Conference Outcomes and Follow-up

To promote the SFDRR, a mechanism is needed to appropriately follow-up on the status of its fulfillment. Key challenges will include monitoring the seven newly established global targets, improving the methods involved, and the development of indicators that measure the progress on newly established priority actions. It is therefore necessary to support the activities of the UNISDR, including these initiatives, and to establish international disaster statistical methods that will contribute to these initiatives.

(2) Promotion of International Cooperation for Disseminating “Build Back Better” (Support for IRP Activities)

Even after the Conference, it is important to keep the international community informed of the progress of recovery from the Great East Japan Earthquake and on initiatives aimed at “Build Back Better.” To do this, it is necessary to use strategies compiled by the International Recovery Platform (IRP) to develop activities in Sendai and Tohoku for collecting and disseminating good practices and for cultivating human resources, and to strengthen the development of systems for this purpose.

Concept of “Build Back Better”

“Build Back Better” is a concept to build more resilient communities throughout the reconstruction phase following a disaster. To reduce the potential risk of disaster damage, it is necessary to build homes in lower risk areas, and to build disaster-resistant urban structures. The reconstruction phase following a disaster is an opportunity to incorporate lessons learned from the disaster experience into fundamental processes like land use planning and the construction of disaster-resilient structures.

The Great Hanshin-Awaji Earthquake of 1995 was an inland earthquake that occurred directly beneath a densely populated urban area. The number of totally collapsed residential structures alone exceeded 100,000 units. Since then, thanks to the concerted efforts of those involved in disaster response, a disaster-resilient community has been reconstructed and earthquake-resistant buildings have been built. This disaster also triggered nationwide efforts to renovate homes and public buildings to make them more earthquake resistant.

The philosophy statement in the Miyagi Prefecture Plan for Recovery from the Great East Japan Earthquake calls for the “creation of a disaster resilient and safe community,” “fundamental ‘reconstruction’ beyond mere ‘reversion,’” and the “construction of a recovery model from devastating damage.” This prompted efforts to relocate the entire community to a more elevated area, to increase the height of the seawall, and to construct a dual-purpose main road system that would allow it to also function as a seawall.

This “Build Back Better” principle is well reflected in the recovery and reconstruction from Typhoon Haiyan which caused devastating damage to the Philippines in 2013. The Government of Japan assisted the Philippines with the development of hazard maps, land use plans, and medium- to long-term plans for the development of disaster-resistant cities. Also, as part of a recovery program sponsored by the Japanese grant, the ground floors of public buildings along the coast are being designed to provide shaded sporting grounds and meeting places for everyday activities, while their second floors can function as emergency shelters in the event of a disaster. Given this aid from Japan, the phrase “Build Back Better” can be seen printed on the cover of the Philippines Government’s Recovery Plan. Clearly this is a sign that lessons from Japan are being disseminated around the world.



The safety of the town was improved after rebuilding roads as wider ones
(Photos at the same location)
Photo: Kobe City

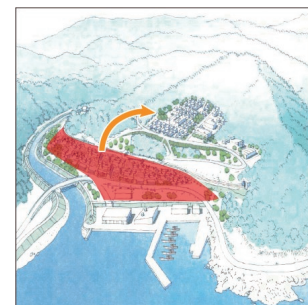

Image: “Relocation of a tsunami-disaster prone area to high ground”
Source: Reconstruction Agency

Section 1: Overview

As discussed in Chapter 2, the Sendai Framework for Disaster Risk Reduction (SFDRR) was adopted at the Third UN World Conference on Disaster Risk Reduction (WCDRR), held in March of this year, to succeed the HFA, adopted in 2005, as the guideline for disaster risk reduction in countries around the world. Over the coming 15-year period, promoting the SFDRR will be the responsibility of the international community, and of Japan as a country which has led the world in the field of disaster risk reduction.

Therefore, in accordance with the Sendai Cooperation Initiative for Disaster Risk Reduction (see page 14) announced by Prime Minister Shinzo Abe, Japan will contribute to the mainstreaming of DRR in the international community by effectively combining the promotion of structural and non-structural supports as well as global cooperation, and region-wide cooperation; contributing a total of four billion dollars to fields related to disaster risk reduction and providing human resources development for 40,000 people over the next four years. Furthermore, Japan will also proactively continue to promote international cooperation in DRR through measures including multilateral cooperation via international organizations such as the UN, regional cooperation in Asia, and intergovernmental cooperation.

Section 2: DRR Cooperation through the UN and Other International Organizations

Disaster phase	Organization/function in charge of overall coordination	Overview
Disaster response	UN Office for the Coordination of Humanitarian Affairs (OCHA; headquarters: New York and Geneva)	Active since 1970s (preceded by United Nations Disaster Relief Organization [UNDRO]) Provides general coordination of international humanitarian aid activities during disasters from headquarters/disaster site. During peacetime, maintain and develop coordination mechanisms for disaster response; scheduled to hold the first World Humanitarian Summit in Turkey in 2016. <i>Note: Japan's donations to OCHA reach approx. 8.6 million dollars (FY2014).</i>
Disaster prevention	UN International Strategy for Disaster Reduction (UNISDR; headquarters: Geneva)	Active since 1990s (preceded by International Decade for Natural Disaster Reduction [IDNDR]) Secretariat in charge of holding the first through third UN World Conference on Disaster Risk Reduction. Implements various awareness-raising activities such as campaign to make cities resilient and the creation of the Global Assessment Report on Disaster Risk Reduction (GAR). <i>Note: Japan's donations to UNISDR reach approx. 1.34 million dollars (FY2014).</i>

International Recovery Platform (IRP)

The International Recovery Platform (IRP) was established after the Second UN World Conference on Disaster Reduction in 2005 to harness initiatives focused on recovery from the Great Hanshin-Awaji Earthquake at its secretariat in Hyogo Prefecture and to aggregate and provide expertise on post-disaster recovery. In May 2005, it was affirmed that the activities of the IRP, as a framework for international support that aggregates and provides information on post-disaster recovery expertise, would be developed through coordination between agencies such as the Government of Japan, UNDP, UNISDR, OCHA, the International Labour Organization (ILO), the Asian Disaster Reduction Center (ADRC), the World Bank, and the International Federation of Red Cross and Red Crescent Societies (IFRC). HAT Kobe (Happy Active Town Kobe; Kobe new eastern city center) was offered as the secretariat for activities by Hyogo Prefecture, and the organization began engaging in international recovery and support activities based on the HFA.

The IRP engages in various activities whose goals include providing a coordination framework and network for post-disaster recovery and needs assessment; facilitating the dissemination of lessons learned and the development of common tools and mechanisms; providing advice and support on the formulation of post-disaster recovery planning and programming; and strengthening national capacities in coordination with long-term development plans. The IRP's activities include holding the annual International Recovery Forum, creating Guidance Notes on Recovery, and conducting human resource development workshops.

The 11th International Recovery Forum was held in Kobe, Hyogo Prefecture in January 2015. This event, whose theme was "Sending the Message of Building Back Better from Hyogo, Japan," attracted 179 people involved in DRR from 36 countries and 27 organizations. In FY 2014, Japan provided support to cover the expenses involved in holding the International Recovery Forum, through a contribution to the UNISDR for expenses to support IRP activities (FY2014: Funding from money donated to the UN: USD 225,000; International Recovery Forum expenses, approx. the 7.5 million yen).

To promote the "Build Back Better" concept around the world, which is a clear priority of the SFDRR, the IRP will have to work on sharing and classifying good practices in recovery, strengthening activities to provide advice and support in ways that leverage accumulated knowledge, and enhancing systems for engaging in these activities.

Sendai Cooperation Initiative for Disaster Risk Reduction

1. Basic Concept

- ◆ Disasters are an obstacle to poverty eradication and sustainable development, and thus a threat to human security.
- ◆ **Mainstreaming of disaster risk reduction (DRR)** - introducing the DRR perspective in all development policy and planning - is important. Clearly positioning DRR in the post-2015 development agenda is important from the perspective of resource mobilization.
- ◆ High attention to the efforts for “adaptation” at the climate change negotiation where an agreement is required by the end of this year. Firm DRR efforts will contribute to the climate change negotiation.
- ◆ Japan will build with the international community a society that is resilient to disasters by sharing with the world its knowledge and technology as a country advanced in DRR.

2. Basic Policies

- ◆ Japan attaches particular importance to the three points in DRR policies outlined below, building on the experience of the past 10 years since the formulation of HFA.
 - (1) **Investment in DRR from the long-term perspective**
Prior investment in DRR is more cost-effective than post-disaster emergency response and recovery and contributes to sustainable development.
 - (2) **Build Back Better**
The post-disaster phase provides an opportunity to implement drastic measures to build countries and regions that are resilient to disasters.
 - (3) **Collaboration between the central governments and various actors**
Addressing with networks including local governments, private companies, NGOs/CSOs, international organizations and regional organizations, with the central government taking the initiative.
 - ◆ Japan will take the following perspectives into consideration in implementing cooperation.
 - (1) **The human security approach** and **promoting women’s participation** (women, children, the elderly and persons with disabilities)
 - (2) Cooperation based on the perspective of **adaptation to the impacts of climate change**
 - (3) Utilizing **Japan’s knowledge and technology**
- ➔ Cooperation through effectively combining (i) non-material assistance, (ii) material assistance and (iii) global and region-wide cooperation.

3. Concrete Measures

DRR cooperation totaling to 4 billion US dollars and training of 40 thousand from 2015 to 2018

Non-material assistance

- Assistance for establishing laws, institutions and systems, human resource development and other technical assistance
- ◆ Laws and regulations relating to DRR (basic acts on disaster countermeasures, laws and regulations on the use of land / building standards)
 - ◆ Basic DRR plans, master plans for flood control, master plans for urban planning, land-use plans, urban planning
 - ◆ Assistance to and strengthening setup of DRR branches in government
 - ◆ Assistance to build and strengthen partnership systems among the public and private sectors and NGOs
 - ◆ Disaster risk assessment (development hazard maps, research assistance for adaption to climate change, etc.)
 - ◆ Technologies for disaster observation, prediction and warning (ICT, earth observation, geospatial information)
 - ◆ Community-based DRR, disaster education
 - ◆ Human resource development, training, technology transfer for DRR policy planning and emergency disaster relief
 - ◆ Training to promote women’s leadership in DRR

Material assistance

- Economic and social infrastructure development with Japanese technology as prior investment in DRR (“quality growth”)
- ◆ Countermeasures against flooding, debris flow, landslides and storm surges, forest improvement for disaster reduction
 - ◆ Satellites necessary for disaster observation, prediction and warning, and information and communication infrastructure
 - ◆ Improvement of buildings quality (earthquake resistance, wind resistance)
 - ◆ Provision of equipment related to DRR
 - ◆ Transportation, lifeline and public facilities resilient to disasters, DRR-related information and communication facilities
 - ◆ Recovery and reconstruction assistance

Global and region-wide cooperation

- Assistance for UNISDR and IRP, region-wide cooperation
- ◆ Assistance for the monitoring of the global targets and the improvement of its methods, as well as for the development of indicators
 - ◆ Development of international disaster statistics
 - ◆ Dissemination of information on good practices of “Build Back Better” including efforts from the Tohoku region
 - ◆ Assistance for efforts to build region-wide institutions and systems (Sentinel Asia, Asian Disaster Reduction Center, AHA Centre, etc.)
 - ◆ Assistance for countermeasures against climate change (including Green Climate Fund (GCF))
 - ◆ Collaboration between regional cooperation of each region and Japan’s bilateral cooperation

Section 3: DRR Cooperation in the Asia-Pacific Region

3-1 Activities of the Asian Disaster Reduction Center (ADRC)

Based on the Yokohama Strategy adopted at the First WCDRR in 1994, which pointed out the need for regional cooperation in collecting and sharing disaster information, the Asian Disaster Reduction Center (ADRC) was established in July 1998 in Kobe, Hyogo Prefecture. It was established after investigations were conducted at ministerial and expert meetings held in countries throughout Asia to apply the lessons learned in Japan to disasters across Asia, including lessons from the 1995 Great Hanshin-Awaji Earthquake. As of June 2015, the ADRC had a network consisting of 30 member countries in Asia and five advisor countries. The organization actively coordinates with a variety of UN agencies, including the UNISDR, as well as other international organizations.

The ADRC pursues four priorities: (1) information sharing on disaster risk reduction, (2) human resource development in member countries, (3) capacity development of communities, and (4) cooperation among member countries, international and regional organizations, and NGOs.

In FY 2014, the ADRC invited eight disaster-related officials as visiting researchers from its member countries, provided trainings for various national government officials, participated in the Sixth Asian Ministerial Conference on Disaster Risk Reduction (in Bangkok), and responded to 18 requests for emergency satellite observations following large-scale disasters.

In addition, in November 2014, the ADRC visited Sukabumi, located on western Java in an area of Indonesia where earthquakes and tsunamis are expected to occur in the future, and Banda Aceh, which was severely damaged by the 2004 Indian Ocean Tsunami. They conducted questionnaires and urban area surveys among 100 residents living in various areas, investigating the status of DRR measures, disaster awareness among residents, and the implementation status of evacuation training.

On March 15, 2015, the ADRC held the Asian Conference on Disaster Reduction 2015 in Sendai as part of the Third WCDRR, attracting 180 people from member countries and international organizations. Co-hosted by the Cabinet Office and the UNISDR, the Asian Conference on Disaster Reduction has been held annually since 2003 with the goal of sharing information on disaster risk reduction in Asia. As this conference was held during the Third WCDRR, a focused discussion was held concerning the disaster experiences of member countries, the progress made on the HFA, and expectations for a new disaster risk reduction framework.

3-2 Disaster Risk Reduction Cooperation in APEC

Asia-Pacific Economic Cooperation (APEC) is a framework for economic cooperation comprised of 21 economies in the Asia-Pacific region. APEC economies account for approximately 50 percent of the world's total GDP and approximately 40 percent of the world's trade volume and population. APEC is a framework for economic cooperation, but its coverage area also happens to be one of the most disaster-prone in the world. Given that awareness of natural disasters is a factor that can impede sustainable development, in recent years the field of DRR has been positioned as one of those most important in the organization. One of the initiatives in this field is the Emergency Preparedness Working Group (EPWG), which is comprised of the member economies. Originally, the EPWG was organized as successor of a task force established in 2005 to deal with the Indian Ocean Earthquake and Tsunami which occurred in December 2004. The goal of the EPWG is to improve DRR capabilities in the APEC region and promote regional cooperation, with meetings being held once to twice per year. In addition, like the ministerial meetings addressing various issues, including the APEC leaders' meetings, each year the Senior Disaster Management Officials Forum (SDMOF) is held on a rotating basis within the region for sharing information and opinions regarding disaster case studies and disaster management in the area covered by APEC.

In August 2014, the eighth SDMOF was held in Beijing, China. It featured a discussion on "Strengthening Science and Technology in Disaster Risk Reduction," which focused on the application of science and technology to increase the efficiency of emergency response and disaster recovery. As part of this discussion, the Government of Japan presented information on the application of science and technology in the recovery from the Great East Japan Earthquake, the state of the recovery in the Tohoku region, and preparations for the Third WCDRR.

Ensuring Systems for the Continuity of Transnational Business Activities

During the flooding in Thailand in 2011, over 400 Japanese companies experienced flooding damage, and local production subcontractor factories and parts manufacturers were forced to suspend production activities. This resulted in a significant influence on the economic front. For example, a company was forced to delay the release of a new digital camera by approximately two months, and local automobile production plants were made to cease production for approximately half a year. In addition, the Great East Japan Earthquake, which occurred in Japan, significantly influenced economic activities both in the country and overseas via supply chains, increasing interest not only among Japanese companies with locations in other countries but also in foreign companies and government agencies as concerns initiatives and methods for business continuity in Japan, a country which frequently experiences natural disasters.

In August 2013, the Cabinet Office announced the third edition of its Business Continuity Guidelines. Believing that the proactive distribution of knowledge concerning business continuity in Japan to other nations is essential, an English version of the guidelines was created in June 2014. In addition, in 2013, ADRC created and shared a business continuity plan guidebook based on the experiences of the Great East Japan Earthquake for small and medium-sized companies in Asian countries.

3-3 Other International DRR Initiatives in Asia and the Pacific

(1) Pacific Islands Leaders Meeting

The Pacific Islands Leaders Meeting has been held since 1997 to strengthen ties between Japan and other Pacific island nations. The Seventh Pacific Islands Leaders Meeting (PALM7) was held in May 2015 in Iwaki City, Fukushima Prefecture. Co-chaired by Prime Minister Abe and the President of Palau Tommy Esang Remengesau, the meeting was attended by leaders from 17 countries. At the Meeting, the “Fukushima Iwaki Declaration: Building a Prosperous Future Together” was adopted, promoting cooperation in seven fields such as disaster risk reduction, climate change, and the environment. Prime Minister Abe also announced Japan’s intention to provide over 55 billion yen in support over the next three years and to provide support for human resource development and exchange opportunities for 4,000 people.

(2) East Asia Summit

The East Asia Summit (EAS) was launched in 2005 to enable leaders to engage in open discussion concerning issues important to East Asia and the international community. Currently, 18 countries participate - the 10 ASEAN member states plus Japan, China, Republic of Korea, Australia, New Zealand, India, the US, and Russia. Disaster risk reduction is seen as one of the priority cooperation fields of EAS. At the ninth EAS held in November 2014, Prime Minister Abe spoke about holding the Third WCDRR in Sendai in March 2015.

(3) Typhoon Committee

The Typhoon Committee (TC) was established in 1968 as an intergovernmental organization under the United Nations Economic and Social Commission for Asia and the Far East (UNESCAP) and the World Meteorological Organization (WMO) with the goal of reducing typhoon damage in the Asia-Pacific region. The TC is comprised of the Working Group on Meteorology (WGM), the Working Group on Hydrology (WGH), the Working Group on Disaster Risk Reduction (WGDRR), the Training and Research Coordination Group (TRCG), and the Advisory Working Group (AWG). Currently, 14 countries and territories participate (China, Hong Kong, Macao, Philippines, Japan, Republic of Korea, North Korea, Vietnam, Cambodia, Laos, Thailand, Malaysia, Singapore, and the US). Each year a general meeting and integrated workshop are held to discuss such topics as the coordination of activities and the direction of future activities .

(4) Coordination and Cooperation with ASEAN Countries

1) The ASEAN-Japan Transport Partnership Project

The Ministry of Land, Infrastructure, Transport and Tourism (MLIT) is implementing various cooperative projects under the ASEAN-Japan Transport Partnership, a framework for cooperation between Japan and ASEAN in the field of transportation. Since 2013, under the Project to Promote Disaster Risk Reduction Cooperation in the Field of Transportation, the Ministry has invited experts from ASEAN nation ministries in charge of transportation to share their expertise on disaster management in the field of transportation. Additionally, the Ministry is in the midst of formulating a collection of DRR good practices in the field of transportation in Japan and ASEAN member states, which is scheduled for completion in 2015.

As part of the same project, the Ministry holds the ASEAN-Japan Port Technology Group Meeting. Starting in 2015, the Group will be implementing a three-year plan aimed at compiling Port Disaster Reduction Guidelines (provisional title). Focused on port disaster reduction, the Guidelines will share lessons learned from the Great East Japan Earthquake with ASEAN member states and will be referenceable when implementing initiatives concerned with port DRR in ASEAN nations.

2) International Symposium on Building the National Resilience of ASEAN Countries

Officials of the National Resilience Promotion Office in the Cabinet Secretariat attended a symposium on building national resilience sponsored by the Economic Research Institute for ASEAN and East Asia (ERIA) held in April 2015. This event was held to share Japan's expertise on and experience with building national resilience with the ASEAN nations, while trying to increase understanding of foreign countries and promote international contributions.

(5) Promoting Sentinel Asia to Share Disaster Information Throughout the Asia-Pacific Region

The decision was made to establish Sentinel Asia at the 2005 meeting of the Asia-Pacific Regional Space Agency Forum (APRSAP) hosted by the Ministry of Education, Culture, Sports, Science and Technology (MEXT) and the Japan Aerospace Exploration Agency (JAXA). The goal of Sentinel Asia is to contribute to disaster management and disaster mitigation utilizing data gained from satellite observations in the Asia-Pacific region. As of April 2015, the participants were comprised of 81 agencies from 25 nations and territories and 15 international organizations. Through cooperation between ADRC and agencies from countries and territories in possession of satellites (India, Thailand, Republic of Korea, Taiwan, and Singapore), Sentinel Asia has created a mechanism for providing satellite observation data through a website when requested by a disaster-stricken country. In 2014, Sentinel Asia provided emergency observations a total of 18 times, including observation images provided by Japan using the ALOS-2 (Advanced Land Observing Satellite-2) in response to the landslide disaster that occurred in central Indonesia in December of the year.

(6) Japan Holds Pan-Pacific INTERPRAEVENT 2014

To promote and disseminate scholarly research on the prevention and mitigation of disasters due to flooding, debris flows, landslides, and avalanches, the MLIT held the Pan-Pacific INTERPRAEVENT 2014 comprehensive international academic conference in Nara Prefecture in November 2014. It was attended by approximately 290 people from 25 countries and territories. In addition to sessions aimed at sharing Japan's advanced erosion control technologies and techniques, keynote speeches, oral presentations, and panel discussions were held to discuss disasters and countermeasures in various countries. The best approaches to research and development that must be taken by the international community were compiled into a proposal statement.

Section 4: Bilateral Disaster Risk Reduction Cooperation

4-1 Japan's Overseas Emergency Disaster Support

To utilize Japan's experience in disaster relief overseas, the government began international emergency assistance activities centering on the dispatch of medical teams in the latter half of the 1970s. The execution of the Act on the Dispatch of the Japan Disaster Relief Team (commonly known as the JDR Act) in 1987 and its revision in 1992 made it possible for Japan to dispatch relief teams, medical teams, expert teams and Japan Self-Defense Force units overseas for the purpose of disaster relief. These four types of teams are dispatched separately or jointly depending on the type of disaster, its scale, and the requests of the disaster-stricken countries. The JDR relief teams have been evaluated by the United Nations as the top classification of "heavy." Further, Japan also provides emergency grants and emergency relief supplies.

In FY2014, for example, the Ministry of Foreign Affairs (MOFA) provided emergency relief goods (through JICA) to support the urgent daily life needs of disaster victims in response to the cyclone that occurred in Vanuatu in March 2015 and the flooding that occurred in Mozambique in January of the same year. In addition, the Ministry provided emergency grants in response to the flooding that occurred in northern India and northeastern Pakistan in September 2014 as well as grants for recovery from and risk reduction for typhoons and earthquakes.

In response to the earthquake that struck Nepal on April 25, 2015, Japan provided emergency relief supplies such as tents and blankets and provided approximately 1.68 billion yen in emergency grants. In addition, the Government of Japan dispatched JDR teams—relief teams to disaster-stricken areas (a total of 70 people: one delegation leader from MOFA, 23 from the National Police Agency, 17 from the Fire and Disaster Management Agency, 14 from the Japan Coast Guard, and 15 from JICA) to engage in search and rescue activities and medical teams (two teams comprised of

46 persons and 34 persons, respectively) to provide medical support in disaster-affected areas. Further, the JDR teams included Japan Self-Defense Force units (114 people from medical aid units) to provide medical treatment and diagnosis in disaster-stricken areas.

4-2 Japan's International Cooperation in the Fields of Disaster Prevention and Recovery

Harnessing the expertise, systems, and technologies cultivated through Japan's numerous disasters, Japan contributes to improving the disaster management system of developing countries through official development assistance (ODA) provided by the MOFA. JICA plays a central role, while enlisting the cooperation of the working ministries and agencies. Going forward, Japan will continue to support the creation of a disaster-resilient society by "mainstreaming disaster risk reduction," that is, the incorporation of DRR viewpoints in the development of various fields.

4-3 Intergovernmental DRR Cooperation Initiatives

(1) Cooperation on Disaster Management Systems

In December 2014, the Cabinet Office concluded a memorandum of cooperation with the US Federal Emergency Management Agency (FEMA), promoting cooperation between the two agencies as regards disaster risk reduction and management. In May of this year, Minister Yamatani and FEMA Administrator Craig Fugate engaged in a policy dialogue. In addition, based on the first Japan-China-Republic of Korea Trilateral Summit held in 2008, the Ministerial Meeting on Disaster Management is held on a rotating basis among the three countries, with the fourth meeting scheduled to be held in Japan this year.

The MLIT engages in the sharing of information concerning expertise and experience from experts and practitioners based on exchanges with the European Commission's Humanitarian Aid and Civil Protection department (ECHO). In addition, the Fire and Disaster Management Agency has held the International Fire and Disaster Management Forum since 2007, providing countries throughout Asia with information on Japan's firefighting techniques and systems.



Bi-lateral Meeting between Minister of State for Disaster Management Yamatani and FEMA Administrator Fugate

(2) Other Cooperation

The MLIT began conducting DRR cooperation dialogues in order to build on Japan's DRR technologies and techniques. MEXT and the Japan Science and Technology Agency (JST) as well as MOFA and JICA are implementing the Science and Technology Research Partnership for Sustainable Development (SATREPS), a program to promote international collaborative research that will aid in resolving global challenges in developing countries. The Ministry of Agriculture, Forestry and Fisheries has been implementing a project since FY 2013 through donations to the UN Food and Agriculture Organization (FAO) in order to help establish stable water resources. Further, trilateral Japan-China-Republic of Korea nuclear power disaster management drills have been conducted, as has a collaborative project with International Telecommunication Union (ITU) utilizing mobile ICT units.

Special Feature: Hyogo's DRR Initiatives

Since the Great Hanshin-Awaji Earthquake, Hyogo has been taking steps to achieve “Creative Reconstruction” and to establish a mature, 21st-century society rather than merely settling for the restoration of pre-disaster conditions.

During reconstruction, Hyogo received vast amounts of assistance from abroad. In an effort to repay this kindness, Hyogo now focuses on disseminating the experiences and lessons learned from the earthquake both at home and abroad, and on cooperating with international disaster risk reduction (DRR) local governments.



Disaster Reduction and Human Renovation Institution (DRI)

Establishment and Operation of the Disaster Reduction and Human Renovation Institution (DRI)

Hyogo co-manages the Disaster Reduction and Human Renovation Institution (DRI) in cooperation with the national government as a base for sharing the experiences and lessons learned from the earthquake. It receives many visitors, both domestic and international. In addition to playing the role of an earthquake museum by collecting, preserving, and exhibiting earthquake-related resources, DRI conducts practical research on DRR using its unique research and survey functions. It trains DRR practitioners and deploys specialists to disaster-affected areas both at home and abroad to provide advice on disaster response activities. DRI takes advantage of the experiences and lessons learned from the earthquake in on-site disaster management and acts as an international hub for DRR activities.

Formation of the Disaster Reduction Alliance

Hyogo invited international DRR organizations such as the United Nations Office for the Coordination of Humanitarian Affairs (OCHA), the United Nations International Strategy for Disaster Reduction (UNISDR), the International Recovery Platform (IRP), the Asian Disaster Reduction Center (ADRC), the Japan International Cooperation Agency (JICA) and others to form the Disaster Reduction Alliance (DRA) and thus strengthen the relationships between these organizations. This work is coordinated by DRI. Thanks to the mutual cooperation of these organizations, Hyogo dispatches experts to disaster-affected areas overseas and accepts trainees from other countries. Furthermore, Hyogo supported the establishment of the Bursa Disaster Learning and Training Center, which is modeled after the DRI, in the Bursa Province of Turkey. In these ways, the lessons that Hyogo learned from the earthquake and subsequent reconstruction activities are being widely applied internationally.

International DRR Cooperation Based on Earthquake Experiences

Hyogo provided support to overseas disaster-affected areas after the earthquakes in Turkey (1999), Northern Taiwan (1999), Sichuan Province, China (2008), and other locations by dispatching specialists with vast knowledge of disaster response. Hyogo also provided practical support based on its experiences as a disaster-affected local government by sending milk bottles and diapers to the Philippines after Typhoon Haiyan in 2013. Hyogo continues to support disaster-affected areas overseas through citizen-funded “donation projects” developed for specific purposes (extending scholarships, reconstructing schools and/or hospitals, etc.) based on the needs of the affected areas.

DRR Cooperation Through UN Organizations

Hyogo Prefecture hosted the Second WCDRR in Kobe City in 2005, the result of which was the adoption of the HFA as an international DRR guideline. Hyogo was recognized as the world's first role model for the "Making Cities Resilient" campaign started in 2010 by the UNISDR. In addition, Governor Toshizo Ido of Hyogo was designated as a Champion (DRR Leader) for his leadership and engagement in important activities, such as advocating the importance of DRR. During the Third WCDRR, Governor Ido, the sole Champion from Japan, introduced lessons learned from the reconstruction efforts that have been implemented in the 20 years since the earthquake and also shared recommendations regarding the adoption of a new DRR framework. New suggestions included the promotion of creative reconstruction, the pursuit of international DRR cooperation among local governments, and the empowerment of local governments to increase their DRR capacity.

Due to its natural conditions, Japan is prone to virtually every type of natural disaster. A variety of natural disasters occurred in 2014, including heavy snowfalls, sediment disasters, volcanic eruptions, and earthquakes. Part II of this report focuses on recent natural disaster risk reduction measures, in particular the status of policies implemented with priority status in 2014.

Section 1: Disaster Management Systems and Disaster Preparedness

1-1 Government's Approach to Crisis Management Organization

Revisions in the government's approach to its crisis management organization are being investigated in the Supplementary Provisions to the Act for Establishment of the Nuclear Regulation Authority 2012 and the Supplementary Resolution relating to a Bill for Partial Amendment of the Disaster Countermeasures Basic Act of 2013. Since it is therefore necessary for the Cabinet Office to investigate the most appropriate crisis management organization for Japan by reviewing the current system, including related ministries and agencies, and making comparisons with the crisis management systems adopted by other major countries of the world, an assembly of the Senior Vice-Ministers of the related ministries and agencies was held in August 2014, chaired by the Senior Vice-Minister of the Cabinet Office, and compiled its final report in March 2015.

The report notes that it is extremely important, in times of crisis when a large-scale natural disaster has occurred, to establish a system that fully demonstrates the strengths of relevant organizations at the national and local levels. Specific responses that would fulfill this objective would include:

- Ensure sufficient staff, including replacements, are dispatched to the Disaster Management Headquarters and provide training to ensure that they can respond appropriately when a natural disaster occurs.
- Develop systems that will allow the integrated implementation of prompt and accurate information sharing and disaster response by the national government and affected local governments. For example, investigate frameworks to enable staff from the organizations of each ministry and agency dispatched to the municipalities, as representatives of the national government, to gather information and respond as needed, and do this in combination with efforts to delineate the chain of command and to strengthen the systems of each ministry and agency.
- The Disaster Management Headquarters, which responds to natural disasters, and the Nuclear Disaster Response Headquarters, which responds to nuclear accidents, should effectively function in a unified manner to prepare for complex disasters.

1-2 Efforts in Human Resource Development and Disaster Management Drills

The basic policy for disaster management drills that are conducted by national and local governments, as well as an overview of the drills that are carried out at the national level, are determined every year by the Central Disaster Management Council in the Comprehensive Disaster Management Drill Framework. In 2014, the following drills were carried out based on the 2014 Comprehensive Disaster Management Drill Framework.

The 2015 Comprehensive Disaster Management Drill Framework was established on March 31, 2015 based on both the disaster drills that were conducted in 2014 and on recent disasters, and the basic approaches to the drills the government plans to conduct are outlined below.

- Implement the government headquarters management drill on Disaster Preparedness Day on September 1 using the scenario of a Tokyo Inland Earthquake
- Urge local governments and private companies to conduct drills around Tsunami Preparedness Day on November 5, encourage the implementation of drills, and conduct large-scale earthquake early warning drills and earthquake/tsunami disaster drills

- Conduct Onsite Disaster Management Headquarters management drills in every region
- Conduct sediment disaster/nationwide disaster drills involving residents
- Conduct drills involving residents, hikers, and tourists based on the evacuation plans formulated by the Volcanic Disaster Management Councils
- Conduct comprehensive disaster management drills that envision a complex disaster involving both a natural disaster and a nuclear power disaster
- Conduct drills to practice road clearance and the removal of abandoned vehicles to rapidly secure emergency transportation routes

<2015 Perspectives on Creating a Comprehensive Disaster Management Drill Framework>

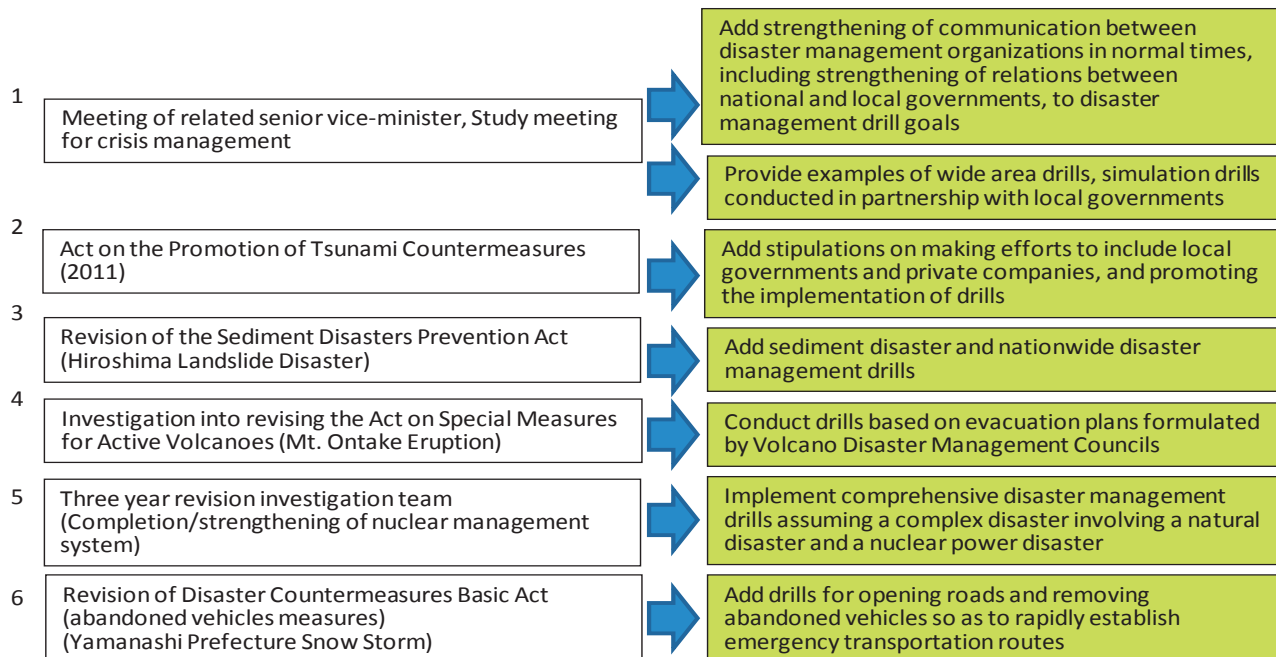

Note: Act on Promotion of Sediment Countermeasures for Sediment Disaster Prone Areas is commonly known as Sediment-related Disaster Prevention Act

Tsunami DRR Efforts

Many precious lives were lost in the tsunami disaster generated by the Great East Japan Earthquake that occurred in March 2011. Using this as a lesson, and with the aim of protecting lives, health, and property from tsunami disasters in the future, the Act on the Promotion of Tsunami Countermeasures was enacted in June of the same year. Under this law, November 5 was designated as "Tsunami Preparedness Day."

In 2014, the Cabinet Office encouraged local governments and private enterprises throughout Japan to conduct earthquake/tsunami disaster drills, including tsunami evacuation drills, around "Tsunami Preparedness Day" on November 5, since human casualties can be dramatically reduced by prompt and efficient evacuation. It also sponsored community earthquake/tsunami disaster drills in eight locations around the country.



Community-participated Earthquake and Tsunami Evacuation Drill (Hamanaka-cho, Hokkaido)



Tsunami Evacuation Drill (Hokkaido Railway Company)

1-3 Implementation of Disaster Risk Reduction (DRR) Education in Communities

To promote DRR education nationwide, the Cabinet Office and Disaster Reduction Education Challenge Plan Committee developed a Manual for the Implementation of Disaster Risk Reduction (DRR) Education in Communities in March 2015. This manual was developed by organizing and analyzing knowledge and know-how needed for the seamless promotion of DRR education, and by examining best practices that can be instructive for those who are trying to start a DRR education program for the first time. It contains tips for solving the various challenges that arise in the process of implementing DRR education programs.

1-4 Construction of Business Continuity Systems Across Sectors

Business Continuity Systems of Government Organizations

The central government's ministries and agencies have formulated their own agency-specific organization continuity plans for the purpose of ensuring the continuity of the pivotal functions of the central government in the event of a Tokyo Inland Earthquake. In March 2014, the Central Governments Business Continuity Plan (Measures for a Tokyo Inland Earthquake) was approved by the Cabinet pursuant to the Act on Special Measures against Tokyo Inland Earthquake (Act No. 88 of 2013). The central government ministries and agencies then revised their own business continuity plans based on the document.

In addition, the Cabinet Office has supported the business continuity efforts of local governments with its Business Continuity Manual for Local Governments During Earthquake Disasters (First Edition). Nonetheless, business continuity plan formulation rates, though growing in recent years, have remained stuck at low levels as before. For this reason, the Cabinet Office produced Business Continuity Plan Formulation Guidelines for Municipalities in May 2015, and is continuing to support the enhancement and strengthening of the business continuity systems of local governments.

<Current Status of Formulation of Business Continuity Plans by Local Governments>

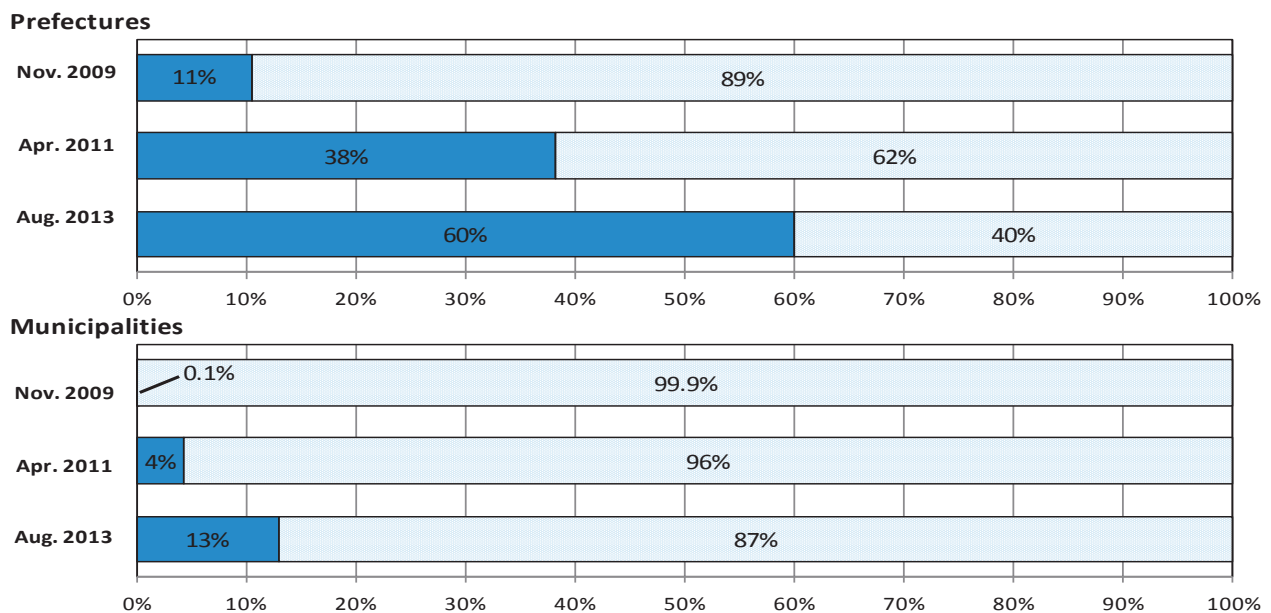

Source: November 2009 Survey of Business Continuity Plans Based on an Earthquake Disaster (Cabinet Office (Disaster Management) and Ministry of Internal Affairs and Communications, Fire and Disaster Management Agency Survey)
 April 2011 Local Government Information Management Report (March 2012) Ministry of Internal Affairs and Communications
 August 2013 Local Administration Bureau Regional Information Policy Office Survey
 Ministry of Internal Affairs and Communications, Fire and Disaster Management Agency Survey (BCP Formulation Rate for Large-Scale Earthquakes and Other Natural Disasters (preliminary figures))

The Cabinet Office had revised its Business Continuity Guidelines for the private sector based on the principles of Business Continuity Management (BCM) so that they not only recommend the formulation of plans, but establish BCM as a type of management strategy. It has been working to disseminate information on the formulation of business continuity plans (BCP) by, for example, formulating instruction manuals for enhancing the understanding of BCM among management, and creating an English version of its business guidelines as a means of sharing information about Japanese BCM efforts overseas. As of the end of March 2014, the data on BCP formulation indicates that formulation efforts are well under way, with over 70% of large companies reporting that they either "have already formulated" or "are in the process of formulating" plans. Among medium sized companies, this percentage is over 40%.

1-5 Communicating Lessons Learned from Disasters

Passing down lessons from past disasters is important for mitigating disaster damage. Since March 2013, the Ministry of Internal Affairs and Communications and the National Diet Library have been operating a portal site (the National Diet Library Great East Japan Earthquake Archive (Hinagiku)) that allows users to centrally search for and use digital data related to the Great East Japan Earthquake. It was designed to help pass down all records and lessons from the Great East Japan Earthquake to future generations and to serve as a resource for recovery and restoration projects, as well as future DRR efforts, in the affected areas.

In February 2015, the Cabinet Office held a Meeting on the Collection, Preservation, and Use of Large-Scale Disaster Information to investigate approaches to the collection, preservation, and use of disaster information, and to examine issues related to the frameworks that exist for collecting and preserving information on large-scale disasters.



**Monument of
the Great Tsunami
(Aneyoshi, Miyako-city, Iwate)**

Section 2: Disaster Response and Preparedness

2-1 Evacuation Directive Decision Making and Communication

The Cabinet Office revised the Guidelines for Producing a Decision and Dissemination Manual for Evacuation Advisories and Orders in April 2014 given the use of new information, such as Sediment Disaster Alert Information, and based on the lessons learned from disasters like the landslide disaster that occurred on Izu Oshima Island in October 2013. They recommended that municipalities issue evacuation advisories, orders, and other directives without fear that they might be unnecessary, and had planned to disseminate the Guidelines through explanatory meetings organized for prefectures and municipalities.

However, following the sediment disaster that occurred in Hiroshima City in August 2014, and based on reports that the timing of evacuation directives had been an issue, in September that year the Cabinet Office and the Fire and Disaster Management Agency requested that all local governments in Japan reexamine their decision-making criteria for the issuance of evacuation directives for sediment disasters. In the case of the sediment disaster that occurred in Tanba City, Hyogo Prefecture also in August 2014, the disaster occurred around midnight. However, the city issued its evacuation advisory earlier, before the disaster had occurred, and thus was able to minimize the number of human casualties.

Although the Guidelines still have not sufficiently been shared at all levels, there are actual examples of governments issuing evacuation directives based on the decision-making criteria established in these Guidelines and of damage having been reduced as a result. Thus, the Cabinet Office plans to continue disseminating the Guidelines in coordination with relevant institutions

2-2 Designated Emergency Evacuation Sites and Evacuation Shelters

When the Great East Japan Earthquake occurred in March 2011, a clear distinction was not necessarily made between “evacuation sites” to which people could flee to escape from the dangers of the imminent disaster and “evacuation shelters” where they could live in places of refuge following the disaster. Furthermore, the evacuation sites were not designated according to the type of natural disaster for which they were intended. Thus, some people fled to evacuation sites immediately after the earthquake only to have these facilities destroyed by the tsunami. This was one cause of damage escalation.

Given this, revisions were made in June 2013 to the Disaster Countermeasures Basic Act establishing new provisions relating to “Designated Emergency Evacuation Sites” and “Designated Evacuation Shelters.” These revisions distinguished between places for emergency evacuation at the time of a natural disaster, and schools and community centers where people could stay for a specific period and live as evacuees.

<Guidelines for Producing a Decision and Dissemination Manual for Evacuation Advisories and Orders>

Timeline

	March 2005	Formulation of the Old Guidelines	
Sep. 2005	Sediment disaster alert information launched	Jun. 2013	Revision of Disaster Countermeasures Basic Act (e.g., provisions guaranteeing seamless and safe evacuation of residents)
Sep. 2006	Revision of designated river flood forecasts	Aug. 2013	Emergency Warning is launched
Mar. 2011	The Great East Japan Earthquake		

Revisions based on new systems, lessons from past disasters

Key Changes

Concept of "evacuation" reconsidered

- "Evacuation" redefined as behaviors engaged in to protect oneself from natural disasters
- Evacuation understood not only to mean going to an evacuation area as before; remaining home and ensuring one's safety is now also recognized as a kind of "evacuation behavior"
 - "evacuation by fleeing" and "securing one's safety at home"
- Demonstrated the concept that there are areas where life-threatening phenomena may occur, where evacuation by fleeing is necessary, depending on the type of disaster
- Principle is established for municipalities to issue evacuation advisories /orders early, without concern that evacuation may not be necessary
 - if evacuation is necessary during the night or early in the morning, issue "evacuation preparation information"

Criteria for issuance of evacuation advisories/orders are clearly defined

- Decision criteria for evacuation advisories/orders are set out as precisely and clearly as possible, and information to be taken into account in decision-making is concretely defined

<p><u>Example of evacuation advisory decision criteria</u></p> <p>Flood: River water level reaches Flood Risk Water Level</p> <p>Sediment disaster: Issue sediment disaster alert information</p> <p>Storm surge: Issue storm surge warning</p> <p>(For tsunamis: Give all evacuation orders when alert is issued)</p>	<p><u>Reference information</u></p> <p>Meteorological information: disaster risk reduction information system (Japan Meteorological Agency, JMA)</p> <p>Water level of rivers: river disaster risk reduction information (Ministry of Land, Infrastructure, Transport and Tourism, MLIT)</p>
--	--
- Support partners have been clarified for the definition of criteria for issuing evacuation advisories/orders and the analysis of DRR meteorological information when the DRR system has been activated
- → JMA Regional Headquarters and Local Meteorological Offices, MLIT River Offices, prefectural Land Development Offices, etc.

Concepts behind municipal DRR systems are presented

- Examples are given of basic concepts relating to the transition stage of municipal DRR systems
 - Examples of DRR meteorological information and DRR systems (for sediment disasters)
 - Heavy rain advisory: System for posting communications personnel and monitoring the weather
 - Heavy rain warning: System for ensuring that governors and mayors get to work and decide when to issue evacuation orders
 - Sediment disaster warning information: All disaster response personnel go to work.

Proposal for mechanism to increase resident awareness of evacuation behaviors

- Proposed a framework for increasing residents' awareness of the disaster risks they face at home, and what steps to take to evacuate if an evacuation advisory/order is issued
 - Natural disaster/evacuation card (card placed in every building that specify which disasters necessitate evacuation and the relevant methods of evacuation)

Future plans

- ❑ Since coordination with DRR institutions is necessary for municipalities to investigate criteria for issuing evacuation advisories/orders, a revision with a target of one to two years will be requested
- ❑ Guidelines will be revised as necessary, as conditions require

(1) Designated Emergency Evacuation Sites

A Designated Emergency Evacuation Site is a place residents can flee to in an emergency when the risk of a tsunami or flooding is imminent. The purpose of these sites is to guarantee the safety of residents.

Item	Type of unusual phenomenon								Total
	Flood	Sediment disaster	Storm Surge	Earthquake	Tsunami	Large-scale fire	Heavy rainfall	Volcanic eruption	
No. of designated sites (sites)	21,459	19,468	5,936	24,888	14,099	15,179	13,995	3,809	37,181
Estimated no. of people accommodated (10,000 people)	3,363	3,713	1,791	5,937	2,571	5,262	2,397	745	8,333

Source: Created by the Cabinet Office based on the Current Status of Regional Disaster Risk Reduction Administration by the Fire and Disaster Management Agency

(2) Designated Evacuation Shelters

A Designated Evacuation Shelter is a facility where residents who have fled due to the dangers of a natural disaster may stay for as long as is necessary until the dangers of that natural disaster have receded. The purpose of these facilities is to offer temporary shelter for residents who are unable to return home due to the natural disaster. Shelters are designated by the municipal government.

At the time of the Great East Japan Earthquake, when many victims were forced to live as evacuees for long periods, authorities observed the mental and physical functional decline of victims as well as the outbreak and worsening of various diseases. Many persons requiring special care experienced problems with the physical elements of the structures, or struggled in their relations with other evacuees, leaving them no choice but to return to life at home.

Given these lessons, the Disaster Countermeasures Basic Act was partially revised in June 2013. To provide for sure access to an appropriate facility where victims could stay in the event of a disaster, stipulations were added to create a system for designating some Evacuation Shelters as Evacuation Welfare Shelters, and to outline the matters that local governments must take into consideration in the development of living environments at Designated Evacuation Shelters. Further, the Guidelines for Ensuring Satisfactory Living Conditions at Evacuation Shelters were formulated and published in August 2013, and the Cabinet Office has been promoting the development of evacuation shelter initiatives by municipalities.

	Designated Evacuation Shelter	Subset of Designated Welfare Evacuation Shelter
Number designated	48,014	7,647

Source: Study on the Current Status of Evacuation Shelter Management (Oct. 1, 2014, Cabinet Office)

2-3 Measures for Handling Abandoned or Stranded Vehicles

In the snow storms of February 2014, many stranded vehicles were left on the roads. These created obstacles for snow-clearing work and caused traffic to be blocked for several days. In December 2013, a proposal entitled “Damage Estimates and Countermeasures for a Tokyo Inland Earthquake” was formulated by the Central Disaster Management Council’s Working Group to Investigate Tokyo Inland Earthquake Measures. This paper demonstrated that damage to the roads themselves, abandoned vehicles, and the increased load on road traffic caused by railway closures could all work together to create severe traffic congestion and impede roadway traffic significantly.

In light of this, and to ensure that a response can be carried out quickly when a natural disaster occurs, the Act to Partially Revise the Disaster Countermeasures Basic Act (Act No. 114 of 2014, hereinafter called the “Revised Act”), which strengthens measures that may be taken against abandoned and stranded vehicles at the time of a natural disaster, was unanimously approved and passed on November 14, 2014. It was promulgated and brought into force on November 21 of that year.

1) Outline of the Revised Act

1. Movement of cars at the time of a natural disaster
2. Instructions from the MLIT and prefectural governors
3. Demands of the Prefectural Public Safety Commissions
4. Loss compensation
 - Road administrators must compensate a vehicle owner if their vehicle is unavoidably lost

2) Practical Application of the Revised Act

As of the end of the FY 2014, the Revised Disaster Countermeasures Basic Act has been effectively applied to 48 sections of expressway and national road.



Moving of the Vehicle Stranded on the Road



Notice Announcing the Forced Removal of the Vehicle Left on the Road

2-4 Measures to Assist Stranded Persons

The Great East Japan Earthquake that occurred in March 2011 left approximately 5,150,000 persons in the metropolitan area stranded, highlighting the need to prepare for the occurrence of a Tokyo Inland Earthquake in the future and to strengthen measures for addressing the needs of stranded persons.

For this reason, the Council on Measures for Stranded Persons Following a Tokyo Inland Earthquake was established in September 2011 to strengthen policies to tackle the problem of stranded persons. Its final report was compiled in September 2012. In light of this report, the Coordinating Council on Measures for Stranded Persons Following a Tokyo Inland Earthquake was established in January 2013. This Council carried out ongoing practical investigations into the guarantee of temporary shelter facilities, and revised the Guidelines on the Guarantee and Operation of Temporary Shelter Facilities in February 2015.

Fundamentally this revision stipulates that temporary shelter facilities are set up and operated from a “public help” perspective, but it demonstrates again the basic need for cooperation, especially from the private sector. It also stipulates the scope of responsibility with regard to the operation and management of temporary shelter facilities and outlines approaches to emergencies.

Based on the final report of the Council, Guidelines for Dealing with Stranded Persons After a Large-Scale Earthquake were formulated on March 2015. These are intended to serve as reference material for the joint investigation by the private and public sector into measures for handling stranded persons in large urban areas, where massive numbers of people are expected to be stranded.

<Guidelines for Dealing with Stranded Persons After a Large-Scale Earthquake>

Guidelines for Dealing with Stranded Persons After a Large-Scale Earthquake

- To address the issues of stranded persons, the public and private sector worked together to establish the Council on Measures for Stranded Persons following a Tokyo Inland Earthquake. These guidelines are a compilation of important stipulations based on the final report from that conference, issued in September 2012, and subsequent investigations.
- Measures to address the needs of stranded persons, while premised on the use of “self help” to the extent possible, require a comprehensive response that also includes “public help.” They require not only the efforts of the national government, local governments, and private enterprises, but also coordinated, cooperative efforts among these institutions.

1. Establish Councils on Stranded Persons

A council will be established in each urban area, whose members will include institutions with connections to the prefecture or city, and relevant institutions will cooperate in investigating responses

2. Regulate mass migration

- Promote thorough understanding of basic principle that reckless movements should be avoided
- Promote creation of worksite waiting facilities for company employees
- Protect users of large-scale tourism facilities and stations

3. Secure temporary stay facilities

- Secure temporary stay facilities through designation by prefectures or municipalities or the execution of agreements
- Aim to accommodate two displaced persons for every 3.3 m³ of floor space, with standard operation of 3 days

4. Prevent crowding around railway stations

- Ascertain the special features of areas where measures for stranded commuters must be taken
- Establish councils whose members include municipalities and relevant institutions, investigate measures for stranded commuters

5. Provision of information to stranded persons

- Provide information on survivors, earthquakes, and damage
- Develop systems for the provision of appropriate information

6. Support for those returning home on foot

Designate stations to provide support for those returning home following a disaster, to provide water and a place to rest, and prepare supported routes with guide maps to assist those walking home

7. Transportation for stranded persons

- Investigate support using buses and other modes of transport for those who are evacuating and need support and who would find it difficult to walk home
- Facilitate cooperation/coordination between the government and institutions connected with transport

8. Steps all citizens can take on a daily basis

Every single citizen must carry out development activities, thinking of disaster conditions even in ordinary times, in order to enable information gathering and walking home etc. to be carried out more smoothly

<Key Changes of the Guidelines for Ensuring and Operating Temporary Shelters>

(1) Creation of forms for agreement

- Provide forms for basic stipulations regarding agreements on the acceptance of stranded persons at temporary stay facilities
- Key stipulations should include the purpose, definitions, publication, establishment, acceptance, details of support, operation, termination of intake, responsibility for costs, damages, and drills.

(2) Completion of check sheet for safety inspections

- The Cabinet Office has drawn up and published “Guidelines on Emergency Inspections by Facility Administrators Immediately following Large-Scale Earthquakes”
- Safety inspections should be carried out by each facility administrator with reference to these guidelines

(3) Presentation of and sign off on the conditions of acceptance

- Those who are taken in should be asked to follow the conditions of acceptance following their consent and signature
- The facility administrator is operating the facility out of good will, from a perspective of mutual help
 - The user shall follow the instructions of the facility administrator
 - In the absence of intention or gross negligence, the facility administrator is not responsible for accidents or other incidents that occur within the facility
 - In the absence of intention or gross negligence, the facility administrator will not be responsible even in the event that those staying at the facility become ill
 - The facility administrator will not look after property belonging to those staying at the facility
 - The facility may occasionally be closed by the decision of the facility administrator if the building is unsafe or if there is a change in conditions in the surrounding area
 - There are some matters, including the medical treatment of the wounded that cannot be dealt with by the facility

(4) Additional notes of caution for acceptance

- Avoid using locations where there is a risk of things falling from the ceiling
- Avoid dark and crowded places, and consider security issues
- Where tenant buildings or mixed-use buildings are used, administrator and owner must cooperate and strive to secure operational staff
- When distributing food stores, confirm best before dates, and carefully investigate the distribution of any stored foods that have passed their best before date
- Where facility users help in the operation of the facility, carry out the same security obligations as with employees

(5) Government support policies

- Prefectures and municipalities should strive towards the dissemination of and education on the following points with respect to temporary stay facilities:
 - Temporary stay facilities are operated by facility administrators out of good will, from a perspective of mutual help
 - There are matters that the facilities cannot address
- The national government, prefectures, and municipalities shall respond with positive cooperation in the event that any damage occurs or there is a risk of damage occurring to a facility administrator in connection with their operation of a temporary stay facility

2-5 Inspections for Controlling the Outbreak of Electrical Fires During Large-Scale Earthquakes

A report entitled “Damage Estimates and Countermeasures for a Tokyo Inland Earthquake (Final Report)” was released by the Central Disaster Management Council’s Working Group to Investigate Tokyo Inland Earthquake Measures in December 2013, once again showed the risk of fires occurring simultaneously in many places in wooden structures crowded together in urban areas. Further, since more than half of the fires that have occurred following major earthquakes in recent years were caused by electricity, this is a problem that clearly needs to be addressed.

In September 2014, the Investigative Committee on Controlling the Outbreak of Electrical Fires During a Large-Scale Earthquake was set up by the Cabinet Office, the Fire and Disaster Management Agency, and the Ministry of Economy, Trade and Industry. It conducted an investigation on the performance evaluation and installation of seismometric breakers, and carried out shaking experiments using mock living rooms. In February 2015, this Committee published guidelines compiling important points regarding the performance evaluation and installation of seismometric breakers.

<Performance Evaluation Guidelines for Seismometric Breakers>

Performance Evaluation Guidelines for Seismometric Breakers

Causes of fires following large-scale earthquakes

More than half of fires following large-scale earthquakes are caused by electricity*

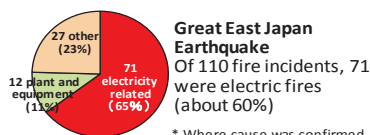
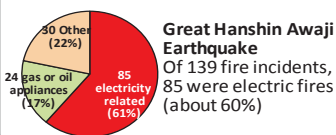

* Where cause was confirmed

Principal places where electrical fires are most likely to occur

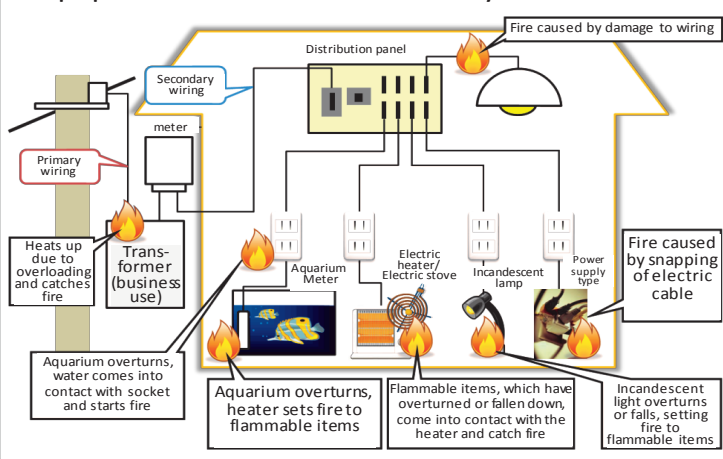

Performance evaluation

Performance evaluation chart

Fire prevention capacity (Mandatory)	Seismometric breaker	“★” – “★★★”
Evacuation safety guarantee function (Optional)	Preventive area	“★” – “★★★”
	Provides lighting	“Possible” or “_”
	Securing continuous electric connections	“Possible” or “_”

Seismometric breaker:

Based on vibration tests below

Preventive area:

From socket to whole house

Provides lighting: Provides lighting in the event of evacuation

Ensures continuous electric connections: Ensures electricity to medical equipment, etc.

- Performance evaluation testing methods for seismically sensitive breakers

Test wave form : Sine wave with specific speed and cycle

Standard: For function (3 wave forms), non-function (4 wave forms)

Simple: For function (1 wave form) and non-function (1 wave form)

Use of third party certification system

Recommended by Japan Electrical Wiring System Industries Association (JEWA) and the Fire Equipment and Safety Center of Japan

Practical use of guidelines

Manufacturers of seismometric breakers

- Guidance on performance evaluation and certification of products
- Confirmation of direction of future development of products

Consumers

- Confirmation of reliability of products
- Selection of products which are adapted to special features and needs of home, confirmation of warnings

Government

- Dissemination and promotion of products certified by a third party

Types of seismometric breakers (images)

Simple type

Breaker is operated by the fall of the weight or the working of the spring, and electricity is cut off



Socket type

Sensor senses tremor and cuts off electricity to socket



Distribution panel type

Sensor senses tremor, drops breaker, and cuts off electricity

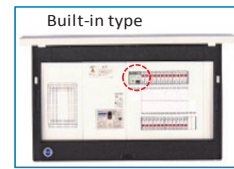

Section 3: Initiatives to Support Disaster Victims

Development and Promotion of a Victim’s Registry

Revisions to the Disaster Countermeasures Basic Act were made in June 2013 to eliminate gaps in support and procedural redundancies when it comes to providing support for disaster victims. These revisions created a victim’s registry system to comprehensively and efficiently provide victim support in the medium to long term and to collect in one central location information on the victim’s status with regard to the damage sustained, support provided, and particular issues that may need to be taken into consideration. The system was launched on October 1, 2013. The Cabinet Office conducted a 2014 Victim’s Registry Survey to seek the further development and promotion of this victim’s registry.

Section 4: Promotion of DRR Activities in Coordination with Various Stakeholders

4-1 Initiatives to Develop an Environment for DRR Volunteers

In the period following the Great East Japan Earthquake until the end of January 2015, more than 1,410,000* volunteers carried out various activities in the disaster-affected areas. However, since no coordination structure was established immediately following the disaster among the support organizations or between the support organizations and the government or NPOs, there was clear dysfunction in the efforts to match the providers of assistance with those requiring assistance.

Given this, the Disaster Countermeasures Basic Act was revised in 2013 to include provisions relating to the coordination between the national government, local governments, and volunteers. The Cabinet Office, in addition to investigating how the coordination between NGOs and the national and local governments would work in the event of a large-scale natural disaster, also carried out drills in Kochi Prefecture and Shizuoka Prefecture in 2013, and Tokyo in 2014, which focused on how coordination between non-governmental support organizations ought to be implemented in the event of a large-scale natural disaster.

*Investigation by the Japan National Council of Social Welfare. Number of volunteers who were active through disaster volunteer centers set up by the Council of Social Welfare in each municipality.



Disaster Management Exercise for Collaboration of DRM Volunteers using the scenario of the Tokyo Inland Earthquake

4-2 Strengthening the DRR Capacity of Communities

Since the “limits of public help” following a large-scale natural disaster is clear, and initiatives based on self-help and mutual help are very important, a Community Disaster Management Planning System has been established to support voluntary DRR activities by community residents.

To disseminate the Community Disaster Management Planning System and support planning activities, the Cabinet Office has been implementing model community projects since 2014. Furthermore, it has published the outcomes of the efforts thus far, so that they can be used as reference by communities that formulate plans in the future.



Evacuation Shelter Set Up Drill at Neighborhood of Fuji City Station South, Shizuoka Prefecture
(Participants include local residents and elementary and junior high school students)

Section 5: Recovery and Reconstruction Measures

5-1 Investigating Measures to Secure Housing for Victims

After the Great East Japan Earthquake, it was pointed out that immediately after the quake, victims were left unclear about how things would turn up from the initial impact until the stage when they would be able to secure permanent housing.

<Securing Housing for Victims (Problems with Current Emergency Temporary Housing)>

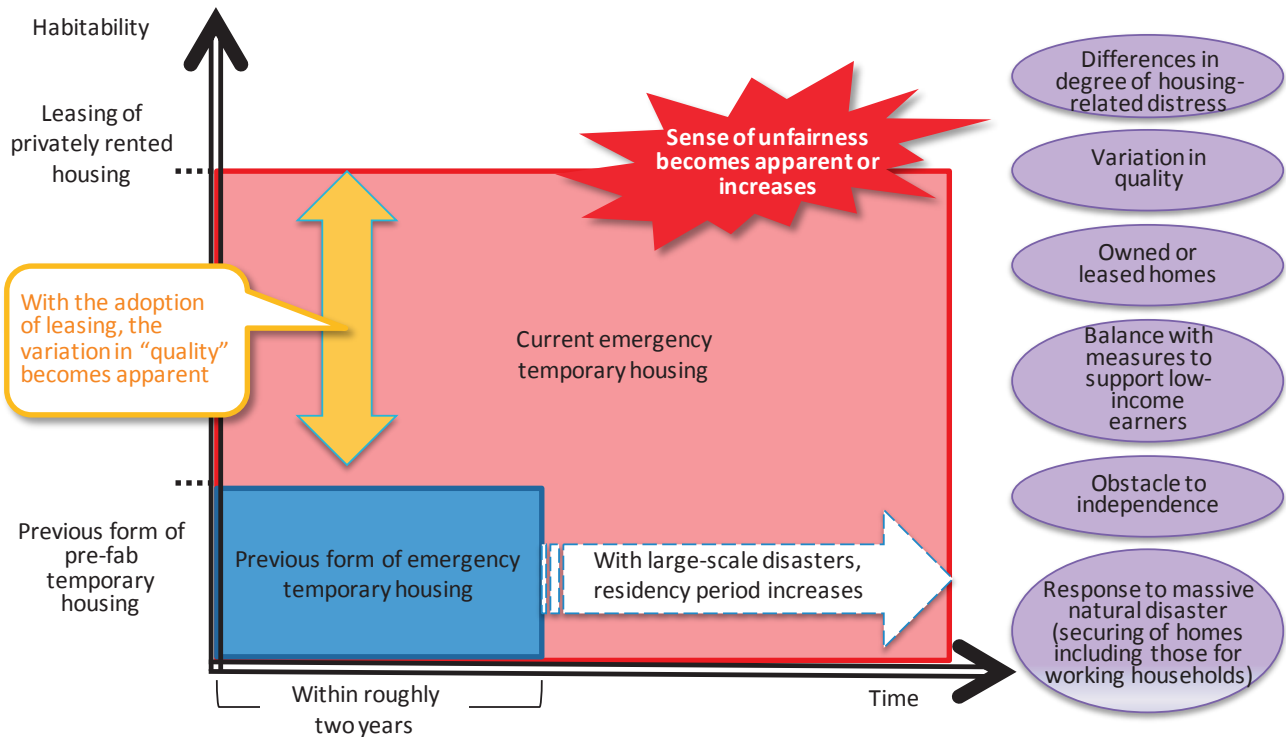

Thus, based on lessons learned from the Great East Japan Earthquake, the Cabinet Office established the Investigative Committee on National Support for Disaster-affected People in October 2013 to carry out a broad investigation into victim support challenges and effective practices in this area.

As this Investigative Committee proceeded with deliberations into effective practices for victim support as a whole, a working group of experts began conducting investigations on efficient and effective access to housing following a natural disaster. In August 2014, the Interim Report was released.

- The definition of temporary emergency housing and approaches to handling in-kind donations
- Balance between conditions for funding and other measures (e.g., measures for low income earners)
- Approaches to the transition to permanent housing
- Approaches to emergency housing repairs

Furthermore, given concerns about the occurrence of a Nankai Trough Earthquake or a Tokyo Inland Earthquake, the following matters must be promptly addressed so that authorities will be able to respond to the massive demand for emergency temporary housing that will result from either of these scenarios:

- Bolster efforts during ordinary (non-emergency) times
- Actively use private rental housing and select methods of granting housing in accordance with the characteristics of each disaster
- Promote proactive collaboration with the private sector
- Build systems for consultation and information sharing relating to the procurement of housing for victims

Section 6: Efforts to Promote National Resilience

The Fundamental Plan for National Resilience (hereafter in this section, the “Fundamental Plan”) was adopted by the Cabinet on June 3, 2014 pursuant to the Basic Act for National Resilience Contributing to Preventing and Mitigating Disasters for Developing Resilience in the Lives of the Citizenry (Act No. 95 of 2013) to address issues of national resilience. The Action Plan for National Resilience 2014 was adopted on the same day at the National Resilience Promotion Headquarters. In light of these, each ministry and agency is currently promoting initiatives relating to national resilience.

The Action Plan 2015 adds an Integrated Progress Index (IPI) in addition to the Action Plan 2014 framework, which will be applied to ascertain the state of progress of the programs as a whole and to compare the states of progress across different programs.

Guidelines for Formulating Fundamental Plans for Regional Resilience are being compiled to enable local governments to more easily formulate their own Fundamental Plans for Regional Resilience (hereafter, “Regional Plans”). Support is also being provided to local governments through the implementation of model surveys. Further, a report entitled “Support by Relevant Government Ministries and Agencies for Initiatives Implemented Based on Regional Plans” was compiled in January 2015, in coordination with related government ministries and agencies, and was published. As of May 11, 2015, 31 prefectures and 13 municipalities were working on formulating their Regional Plans, while four prefectures and three cities had already completed their plans.

<Local Governments that have Published Initiatives (Including Planned Initiatives) for the Formulation of Fundamental Plan for National Resilience>

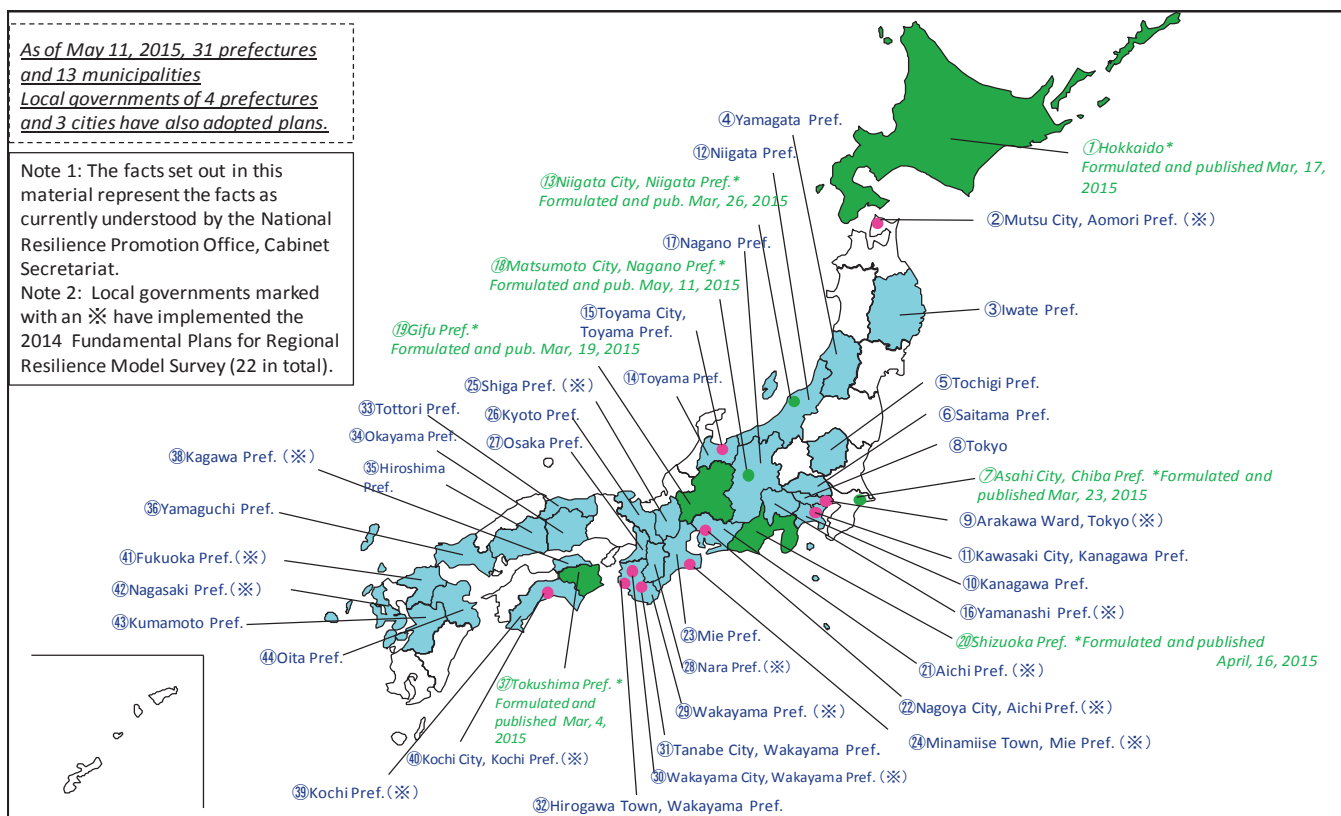

Section 1: Earthquake and Tsunami Disaster Management

1-1 Nankai Trough Earthquake Measures

On March 28, 2014, the central government, via the Central Disaster Management Council, approved the Basic Plan for the Promotion of Nankai Trough Earthquake Disaster Risk Reduction Countermeasures based on the Act on Special Measures for the Promotion of Nankai Trough Earthquake Disaster Management.

On March 30, 2015, the Central Disaster Management Council voted to approve the Plan for Specific Emergency Countermeasures and Activities for a Nankai Trough Earthquake. This plan specifically defines the details of activities related to emergency transportation routes, rescue, firefighting, medical activities, goods procurement, fuel supplies, and disaster management bases for disaster emergency response by the central government. These detailed activities are based on the results of estimates of seismic intensity distribution and tsunami heights for a megaquake and tsunami as predicted by the Committee for Modeling a Nankai Trough Megaquake. They are based on the latest scientific knowledge and damage estimation reported by the Working Group for Investigating Nankai Trough Megaquake Countermeasures.

<Outline of Plan for Specific Emergency Countermeasures and Activities for a Nankai Trough Earthquake>

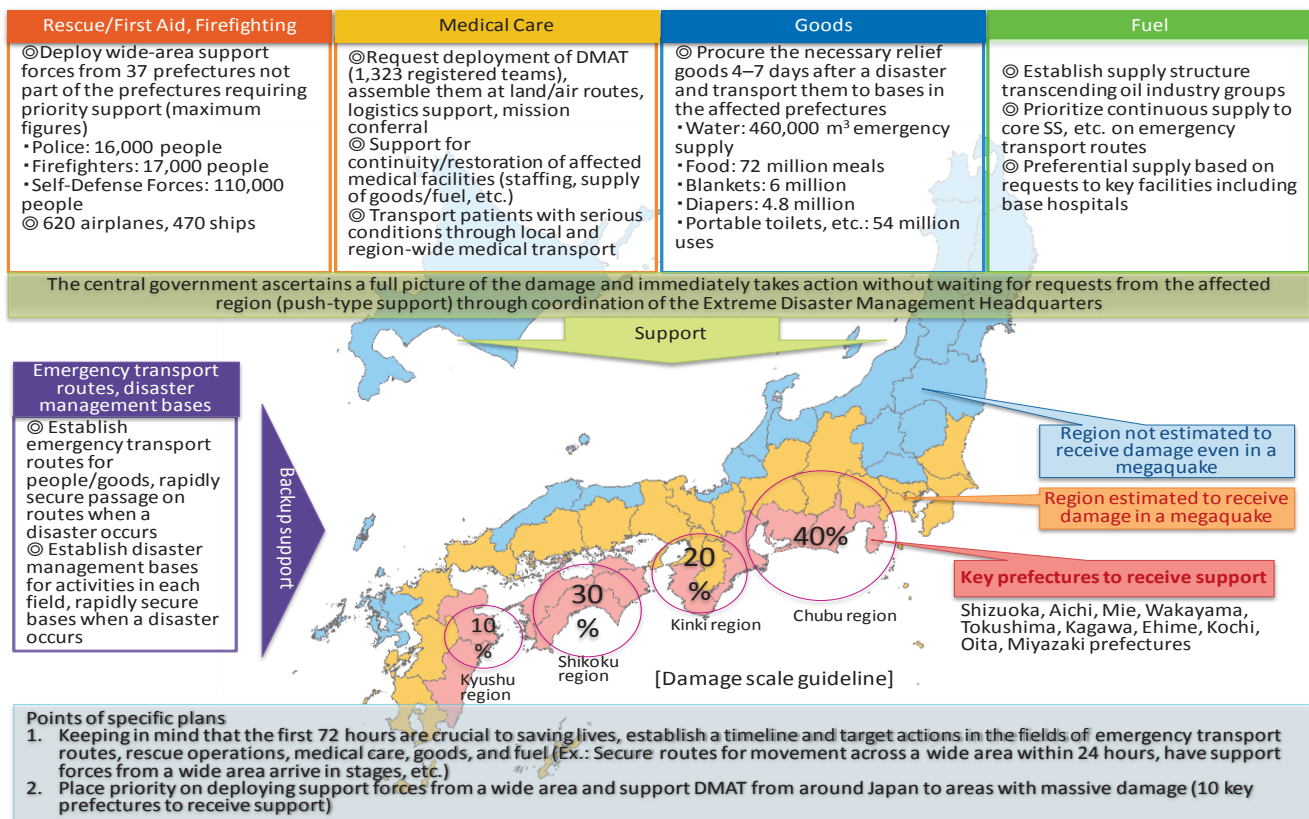

1-2 Earthquake Disaster Management for a Tokyo Inland Earthquake

On March 28, 2014, the Cabinet approved the Basic Plan for the Promotion of Tokyo Inland Earthquake Emergency Countermeasures (hereafter, the TIE Basic Plan) pursuant to the Act on Special Measures against Tokyo Inland Earthquake. A year later, on March 31, 2015, the Cabinet approved revisions to the plan.

This plan stipulates the necessity of two items to reduce damage caused by a Tokyo Inland Earthquake: (1) the construction of systems for ensuring the continuity of the pivotal functions of the central government, and (2) the formation of "earthquake-resilient communities" by systematically and strategically promoting the development of prevention measures and seamless and rapid response measures. The plan outlines the following basic guidelines regarding the policy measures the government absolutely must implement.

- Development of operations continuity systems for central government institutions and the maintenance of

lifelines and infrastructure to sustain the system.

- Seismic reinforcement and fire prevention measures as a major premise to all measures, serious measures to address road traffic paralysis, and measures for assisting large numbers of evacuees and stranded persons.
- Promotion of efforts throughout society based on the concepts of "self-help," "mutual help," and "public help" in which all members of society work together.
- Disaster Preparedness for the period of the Tokyo Olympic and Paralympic Games in 2020.

On March 31, 2015, the Cabinet approved revisions to the TIE Basic Plan. In the plan, the government set quantitative disaster mitigation goals with specific deadlines and set specific goals for policies measures intended to achieve these goals.

<Overview of Changes to the Basic Plan for the Promotion of Tokyo Inland Earthquake Emergency Countermeasures (Establishment of Disaster Mitigation Goals in Tokyo Island Earthquake Measures)>

Past History of Tokyo Island Earthquake Measures	
Sept. 2005	Outline of the Tokyo Inland Earthquake Measures (established by the Central Disaster Management Council)
Apr. 2006	Earthquake disaster risk reduction strategy for a Tokyo Inland earthquake (established by the Central Disaster Management Council)
Dec. 2013	↓ Great East Japan Earthquake (March 2011) Act on Special Measures against Tokyo Inland Earthquake enacted Damage Estimates and Countermeasures for a Tokyo Inland Earthquake (Final Report)
Mar. 2014	↓ Basic Plan for the Promotion of Tokyo Inland Earthquake Emergency Countermeasures (Cabinet approved), Business Continuity Plan of the Central Government (Measures against a Tokyo Inland Earthquake) (Cabinet approved)

↓ **Disaster mitigation goals are conceived** and defined in the Basic Plan for the Promotion of Tokyo Inland Earthquake Emergency Countermeasures

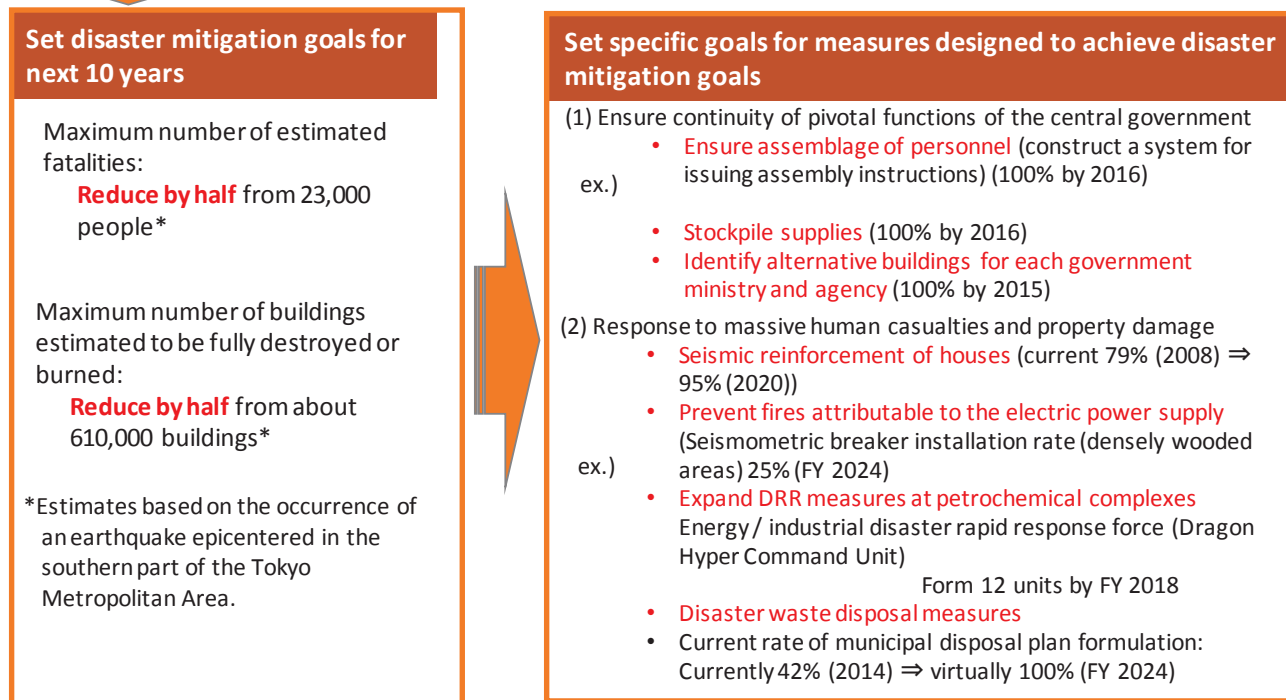

Section 2: Volcano Disaster Management

On September 27, 2014, a volcanic eruption at Mt. Ontake, located along the border between Nagano and Gifu Prefectures, occurred while many hikers were near the peak of the mountain. It happened around noon on a day during the fall season of changing colors. The eruption caused large numbers of fatalities and injuries near the edge of the crater due to the ejection of material in conjunction with the eruption.

The Emergency Management Headquarters established Urgent Measures for the Prevention of Disasters Related to

Volcanic Eruptions on October 28 of the same year, and related ministries and agencies including the Cabinet Office, Fire and Disaster Management Agency, and Japan Meteorological Agency, working in collaboration with relevant institutions, promoted emergency measures.

<Bill to Revise the Act on Special Measures for Active Volcanoes >

Based on the lessons learned from the eruption of Mt. Ontake and the particular features of volcano DRR measures, necessary measures are being taken to strengthen active volcano disaster management measures through the development of alert and evacuation systems that involve collaboration among all stakeholders in volcano communities.

1. Background

- Since eruptions can happen without any clear warnings, rapid information dissemination and evacuation instructions must be made to residents, hikers and others. (Lesson learned from Ontakesan (Mt. Ontake) Eruption)
- Volcanic phenomena vary and response measures must be made on the individual characteristics of each volcano (geography and eruption history). Thus, various stakeholders must work together to investigate policies that incorporate expert findings for each volcano.



2. Bill Overview

Formulation of Basic Guidelines on the Promotion of Active Volcano Management by the national government (Article 2)

- **Development of alert and evacuation systems in volcanic eruption hazard areas**

Designation of volcanic eruption hazard areas (Article 3)

Government designates communities that must promote the development of alert and evacuation systems (primarily communities around volcanoes that are subject to regular observation)

Volcano Disaster Management Councils (Article 4)

...Stakeholders must work together to investigate policies that incorporate expert findings.

- Prefectures and municipalities establish **Volcano Disaster Management Councils (mandatory)**

Required Members

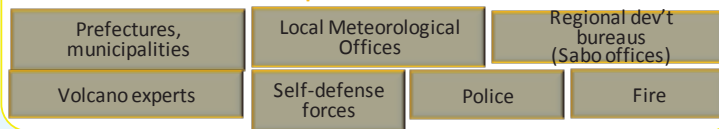

Add as needed

Tourism organizations, etc.

Others, including environmental offices, forest management offices, transportation and telecommunications companies, etc. Possibly also managers of consumer facilities and mountain huts.

Items for Discussion

- **Integrated alert and evacuation systems**, including the establishment of volcanic alert levels and the construction of corresponding evacuation systems

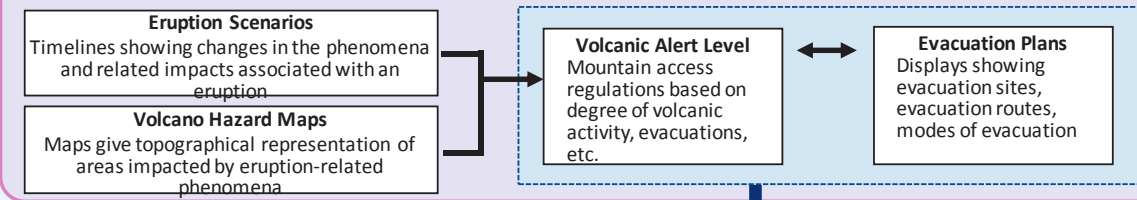

Results of council hearings are reflected in Local Disaster Management Plans (mandatory)

Prefectures (Article 5)

1. Collection and dissemination of information on the occurrence and movement of volcano phenomena, issuance and dissemination of forecasts and warnings (in prefectures)

2. Standards for determining items (2) and (3) at right

3. Regional coordination of evacuation and rescue activities etc.

Municipalities (Article 6)

1. Collection and dissemination of information on the occurrence and movement of volcano phenomena, issuance and dissemination of forecasts and warnings (in municipalities)

2. Announcements made by municipalities regarding evacuation, such as evacuation preparations (volcanic alert level)

3. Evacuation sites, evacuation routes

4. Names and addresses of consumer facilities, facilities used by vulnerable populations
5. Evacuation drills and rescue activities etc.

Mandatory Info Dissemination to Residents by Municipal Leaders (Article 7)

Disseminate information required to ensure efficient alerts and evacuations, such as evacuation sites, by distributing volcano hazard maps. A volcano hazard map



Mandatory Creation of Evacuation Plans (Article 8)

Creation of plans and implementation of drills by managers of consumer facilities (e.g., ropeway stations, hotels) and facilities used by vulnerable populations

- **Strengthen interactions between volcano research institutions, cultivate and secure volcano experts (Article 30)**
- **Obligation to make efforts of local governments and hikers (Article 11)**
 - New regulation requiring efforts by local governments to obtain hiker information
 - New regulation requiring efforts by hikers (to collect volcano information, secure means of communication)

These included urgent measures such as the performance of emergency surveys on the development of information communication mechanisms and evacuation facilities, the establishment of Volcanic Disaster Management Councils at all continuously monitored volcanoes (47 in Japan), the appropriate provision of information and safety measures for hikers and tourists, and the strengthening of volcano observation systems. Volcanic Disaster Management Councils were established for all 47 volcanoes in March 2015.

In December 2014, the Working Group for the Promotion of Volcanic Disaster Prevention was established under the Central Disaster Management Council's Disaster Management Implementation Committee to bridge the lessons learned from the eruption of Mt. Ontake to the further promotion of volcano disaster management measures, and it began conducting additional investigations into longstanding volcano DRR measures. This Working Group met four times. Based on discussions held at relevant investigation committee meetings, such as meetings of the Coordinating Committee for the Prediction of Volcanic Eruptions, and over the course of consultations with experts and relevant government ministries and agencies, the Working Group compiled a Report on Future Volcano DRR Promotion Based on Lessons from the Eruption of Mt. Ontake (March 2015). Based on these proposals, the Cabinet Office passed a bill on May 29, 2015 that partially revised the Act on Special Measures for Active Volcanoes to include provisions to bolster alert and evacuation systems to be developed by relevant stakeholders in communities with volcanoes. This bill was then submitted to the 189th Diet.

On May 29, 2015, a volcanic eruption occurred on Kuchinoerabushima Island in Kagoshima Prefecture. The national government supported evacuees in collaboration with Yakushima City and Kagoshima Prefecture by holding disaster management meetings among related ministries and agencies, dispatching a government investigation team led by Senior Vice-Minister Ryosei Akazawa, and establishing an onsite contact office in Yakushima.

Section 3: Sediment Disaster Management

Japan experiences many sediment disasters every year, but in 2014, due to heavy rain that took place in August, a series of sediment disasters caused human casualties in communities all across Japan. On August 20, as many as 74 people were killed in a landslide in Hiroshima city.

On September 5, 2014, the Emergency Management Headquarters formulated its Key Disaster Prevention Measures for Sediment Disasters and Other Massive Disasters in which it presented measures that related ministries and agencies must urgently develop in order to prevent the recurrence of a large-scale disaster of this magnitude. These include the urgent dissemination of information about sediment disaster risk areas to citizens, urgent investigations of the government's systems development, efforts aimed at providing accurate disaster risk information, and the implementation of more practical exercises on how to prepare for a sediment disaster.

As of November 2014, a revised version of the Act on the Promotion of Sediment Countermeasures for Sediment Disaster Prone Areas (Act No. 57 of 2000; hereafter, the Sediment Disasters Prevention Act) was enacted in the following January.

In December 2014, the Working Group for Studying Comprehensive Countermeasures for Sediment Disasters was established under the Central Disaster Management Council's Disaster Management Implementation Committee for the purpose of compiling the challenges that were revealed by the series of sediment disasters that included the Hiroshima landslide, and connecting the lessons learned from these disasters to the improved promotion of sediment disaster management policies in the future. As a result of the discussions of this Working Group, a Report on the Promotion of Comprehensive Countermeasures against Sediment Disasters was compiled. This report contains recommendations regarding the assessment and sharing of basic information about sediment disasters and local disaster risks, the communication of disaster risk reduction information to citizens, timely and appropriate evacuation behaviors by citizens, and rapid response activities starting immediately after the disaster occurs.

Key Disaster Prevention Measures for Sediment Disasters and Other Massive Disasters

Although the Sediment Disasters Prevention Act was enacted in 2000 based on lessons learned from a landslide in Hiroshima in 1999, another much larger disaster struck the area once again. The following key efforts are therefore, again, being made by relevant ministries and agencies to prevent the recurrence of similar large-scale disasters in the future.

1. Launch investigations into revising the Sediment Disasters Prevention Act

Investigate the following based on lessons learned from the delayed identification of sediment disaster hazard zones:

- Publish survey results as soon as basic surveys are completed
- Require prefectures to share information (sediment disaster alert information) with municipalities

2. Urgent dissemination, urgent inspections

(1) Urgently disseminate hazardous area information to the public

To improve public awareness of disaster management issues and relevant hazards, prefectures and municipalities must work together to disseminate information on potential sediment disaster risk areas (about 530,000 sites) and sediment disaster hazard zones (about 350,000 zones). Includes:

- Sediment disaster hazard zones; and
- Potential sediment disaster risk areas that have not been designated as sediment disaster hazard zones, as well as the surrounding areas likely to be impacted

Disseminate information on hazard maps and evacuation sites using websites, newsletters, circulation of drawings, and posting at public facilities to ensure that the public understands the risks they face

(→ Begin sharing information as quickly as possible, aiming to do so within one week of a request of the national government)

(2) Urgently inspect government systems development

For all potential sediment disaster risk areas (about 530,000)

- Circulation of the site's status as a hazardous location
- Standards for the issuance of evacuation advisories/orders
- Information dissemination methods
- Circulation of information on evacuation sites
- Implementation of disaster drills

Prefectures and municipalities will urgently conduct general inspections of the current status of alert and evacuation systems (→ Aim to conduct inspections within one month of a national government request)

3. Provide accurate disaster risk information, even overnight

- (1) Thoroughly disseminate and confirm the Guidelines for Producing a Decision and Dissemination Manual for Evacuation Advisories and Orders
(→ Disseminate to local governments in early September, conduct confirmation surveys in November)
- (2) Promote the development of emergency alert emails in municipalities, promote the installation of household receivers for prefectural/municipal disaster management radio communications system
(→ The emergency alert email system development rate is 93.2% of all municipalities (as of Aug. 2014; promptly strive for 100%))
- (3) Introduce and apply the L-Alert (disaster information sharing system) in all prefectures
(→ Aim to get all prefectures to decide in FY 2014 to introduce L-Alert, a shared platform for sending out local disaster information all at once via multiple media.)

4. Hold practical drills in preparation for a sediment disaster

Focus on the following points when conducting drills to encourage residents to actively evacuate:

- Information sharing and advice from national and prefectural governments aimed at encouraging municipalities to make early decisions
- Appropriate evacuation behavior by residents based on weather and timing (selection of evacuation sites, measures to find safety indoors when it is dangerous to be outdoors)

Section 1: Review of the Nuclear Regulation Authority and the Cabinet Office Nuclear Disaster Management System

On October 14, 2014, to enhance the government's overall system of nuclear disaster risk reduction (DRR), the existing system of operations related to strengthening local nuclear DRR, which had been implemented by Nuclear Regulation Authority (NRA) officials concurrently serving as members of the Cabinet Office, was reviewed, and a dedicated organization was launched under a Cabinet Office Director-General for Nuclear Disaster Management.

This organization works on reinforcing Japan's off-site emergency response when a nuclear disaster occurs. It provides support for the creation of local disaster management plans and evacuation plans by relevant local governments, offers financial support for DRR measures taken by local governments, and conducts nuclear disaster drills. It establishes Local Nuclear Disaster Management Councils in each community where a nuclear power plant is located, and works on improving and developing more concrete measures for local emergency response, including evacuation plans.

Revision of the Organizations for Strengthened Nuclear Disaster Risk Reduction System

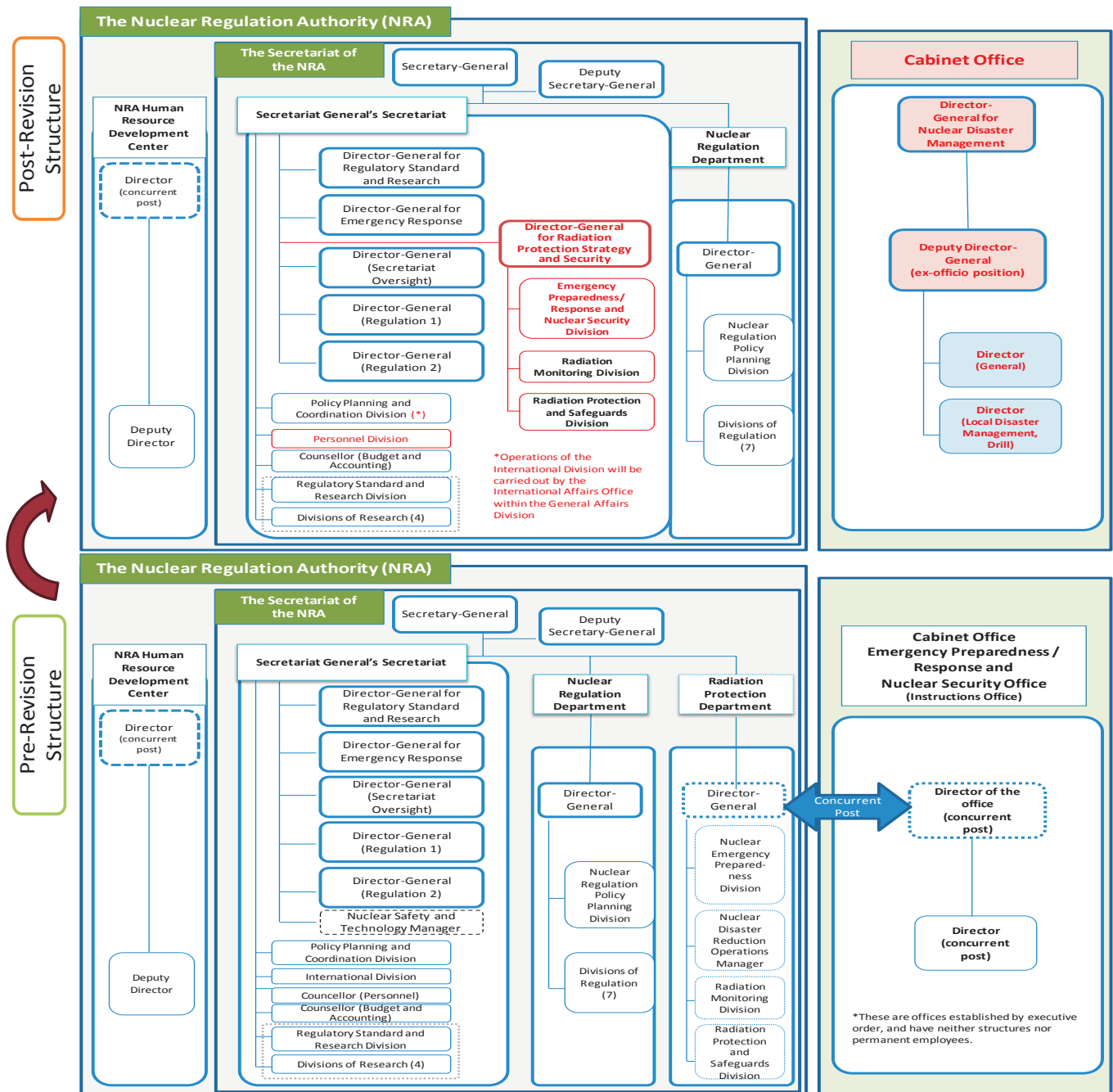

With this reorganization, the Radiation Protection Department of the NRA was abolished and a new position of Director-General for Radiation Protection Strategy and Security was established within the Secretary-General's Secretariat to serve as the new Director-General for Nuclear Security, Nuclear Materials Protection, and Radiation Countermeasures, and a Nuclear Security Division was set up under the Director-General for Radiation Protection Strategy and Security.

On January 15, 2015, five permanent employees were installed to bolster and strengthen emergency monitoring systems in the neighborhoods around all nuclear power plants.

Section 2: Bolstering Nuclear Disaster Management and Radiation Monitoring Under the NRA

(1) Efforts in Nuclear Disaster Management

On September 19, 2012, in conjunction with the establishment of the NRA, revisions were made to relevant laws like the Atomic Energy Basic Act (Act No. 186, 1955) and the Act on Special Measures Concerning Nuclear Emergency Preparedness (Act No. 156, 2009) that resulted in the construction of a new government framework for nuclear disaster management.

On October 14, 2014, the government created a new post of “Cabinet Office Director General” for Nuclear Disaster Management, and placed the secretariat of the Nuclear Emergency Response Headquarters, which had previously been overseen by the Nuclear Regulatory Agency, under its oversight.

Nuclear Disaster Management System

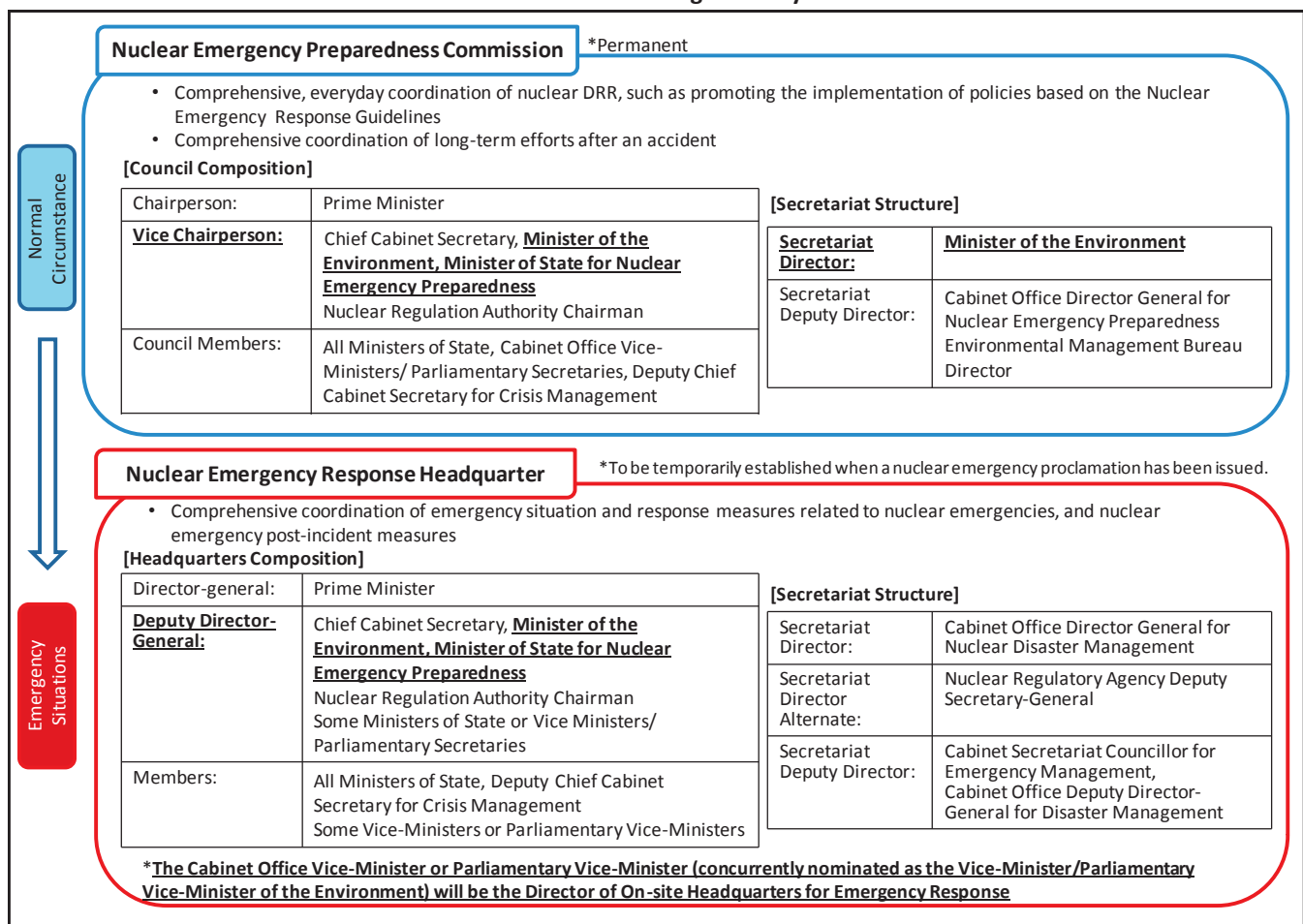

Under the Act on Special Measures Concerning Nuclear Emergency Preparedness, the NRA was tasked with establishing nuclear emergency response guidelines to ensure the seamless implementation of nuclear disaster management measures by businesses, the national government, and local governments. These guidelines were formulated by the NRA in October 2012, and underwent two revisions, in FY 2012 and FY 2013. Since October 2014, an investigation team on nuclear emergency preparedness had been examining nuclear emergency response measures related to the Fukushima Daiichi Nuclear Power Plant, which were addressed in these guidelines, as well as the scope and determination standards for protective measure implementation in the event of plume passage outside of the Urgent Protective action planning Zone (UPZ). Proposed revisions based on the results of this investigation were compiled in March 2015 and were opened to public comment.

(2) Emergency Response Efforts

The Nuclear Regulation Authority has been holding meetings since FY 2013 for reporting on and evaluating the nuclear operator disaster drills that have been conducted pursuant to the Act on Special Measures Concerning Nuclear Emergency Preparedness. At the report meeting in FY 2014, opinions were exchanged with nuclear operators on the current status of efforts taken to address common issues identified in the previous year, as well as future concerns. It was also reported that drills had been bolstered since the previous year.

Also, the secretariat of the Nuclear Regulatory Agency participates in nuclear operator drills and pursues best practices in widespread information sharing with the Nuclear Regulatory Agency Emergency Response Center and the nuclear facility readiness centers. The crisis management efforts of the Nuclear Regulation Authority have included necessary systems development, such as the reorganization of the Cabinet Office and the NRA on October 14, 2014 and the revision of the NRA's Disaster Management Operations Continuity Plan. With the creation of a night and shifts check list and the implementation of practical trainings, efforts are being made to maintain and improve initial response capabilities based on the NRA Initial Response Manual.

(3) Bolstering Radiation Monitoring

To perform effective emergency monitoring based on the Nuclear Disaster Management Guidelines, the Nuclear Regulatory Agency developed Guidelines for Creating an Emergency Monitoring Plan on June 12, 2014 and Guidelines for Establishing an Emergency Monitoring Center on October 29, 2014. The NRA bolstered its emergency monitoring systems by formulating a Mobilization Plan for Emergency Monitoring on January 21, 2015.

Pursuant to the Comprehensive Radiation Monitoring Plan established by the government (approved by the Monitoring Coordination Council on August 2, 2011, revised April 1, 2014), the NRA conducts monitoring related to the Fukushima Daiichi Nuclear Power Plant accident. It monitors aerial radiation rates in Fukushima Prefecture and throughout Japan, and publishes its results weekly.

In addition, the NRA provided support for environmental radiation level surveys in all 47 prefectures, ocean water radiation analyses in areas around nuclear power plants (all 16 seas), and radiation surveys conducted by the locations and neighboring prefectures of nuclear facilities (24 prefectures). The NRA also offers training for local government employees responsible for monitoring operations.

(4) Accidents and Problems

The Nuclear Reactor Regulation Act requires nuclear operators to report accidents that occur at nuclear power facilities to the NRA. Of the reports received in FY 2014, six came from nuclear operators and two came from operators dealing with radioisotopes.

Section 3: Implementation of a Comprehensive Nuclear Disaster Drills in FY 2014

On November 2-3, 2014 a comprehensive nuclear disaster drill was conducted with the cooperation of the Government of Japan, local governments, and nuclear operators at the Hokuriku Electric Power Company Shika Nuclear Power Station pursuant to the Act on Special Measures Concerning Nuclear Emergency Preparedness. The scenario used in this drill was a compound disaster involving both a natural and nuclear disaster, and drills were conducted on internal government communications for handling a compound disaster, such as joint meetings between the Emergency Management Headquarters and the Joint Headquarters for Nuclear Emergency Response.



EMERGENCY SUPPLIES CHECKLIST

Let's be prepared for disasters!

Items to be stockpiled at home in case of a disaster

Prepare a supply of drinking water, food and consumables for one week, if possible

✓	Drinking water (minimum three days' supply, roughly three liters per person per day)	✓	Food (minimum three days' supply) Rice, Packaged foods, Cookies and crackers, Chocolate bars, Hardtack, etc.
✓	Toilet paper, Tissues	✓	Matches, Candles
✓	Cling film, Garbage bags, Flashlight	✓	Plastic water tank

Items to be prepared in a grab-and-go bag as an Emergency Supply Kit

Prepare a flashlight, a portable radio and a charger for electronic devices, preferably ones that can be manually recharged

✓	Drinking water	✓	Bank passbook, Personal seal, Cash	✓	Portable radio with extra batteries
✓	Food Rice, Packaged foods, Cookies and crackers, Chocolate bars, Hardtack, etc.	✓	Clothes, Underwear	✓	Toiletries
		✓	Kairo (disposable body warmers)	✓	Matches, Candles
✓	First aid supplies Adhesive bandages, Bandages, Antiseptic solution, Medicines, etc.	✓	ID Card and card showing contact information	✓	Masks, Work gloves
		✓	Blankets, Towels	✓	Flashlight
✓	Helmet, Disaster prevention hood	✓	Wet wipes	✓	Charger for mobile phone
✓	Milk, diapers, and other necessary supplies for those with infants				